



# Important Safety Information

Be sure to read all the safety information before you begin to use this product.

**WARNING:** To reduce the risk of fire or shock hazard, do not expose camcorder or AC adapter/charger to rain or moisture.

## CAUTION

RISK OF ELECTRIC SHOCK  
DO NOT OPEN



This symbol indicates “dangerous voltage” inside the product that presents a risk of electric shock or personal injury.

## ATTENTION

RISQUE DE CHOC ELECTRIQUE  
NE PAS OUVRIR



This symbol indicates important instructions accompanying the product.

TO REDUCE THE RISK OF ELECTRIC SHOCK, DO NOT REMOVE THE COVER (OR BACK). NO USER-SERVICEABLE PARTS ARE INSIDE. REFER SERVICING TO QUALIFIED SERVICE PERSONNEL.

## Cautions

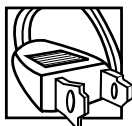

**CAUTION:** To prevent electric shock, match wide blade of plug to wide slot, fully insert.

**ATTENTION:** Pour éviter les chocs électriques, introduire la lame la plus large de la fiche dans la borne correspondante de la prise et pousser jusqu'au fond.

To reduce risk of injury, charge only rechargeable batteries recommended by the manufacturer for this camcorder. Other types of batteries may burst causing damage and personal injury.

FCC Regulations state that unauthorized changes or modifications to this equipment may void the user's authority to operate it.

## Product Registration

Please fill out the product registration card and return it immediately. Returning this card allows us to contact you if needed.

Keep your sales receipt for proof of purchase to obtain warranty parts and service and attach it here. Record the serial number and model numbers located on the bottom of the camcorder.

Model No: CC6263

Serial No: \_\_\_\_\_

Purchase Date: \_\_\_\_\_

Purchased From: \_\_\_\_\_

## Assistance

We want to make sure you enjoy your new camcorder. If you have any questions, call:

**Camcorder Exchange Warranty.....800-283-6503 (pages 76-77 )**

**Customer Service.....800-336-1900 (page 75 )**

**Accessories..... 800-338-0376 (pages 62-67)**

## Table of Contents

|                                      |           |                                    |           |
|--------------------------------------|-----------|------------------------------------|-----------|
| <b>Assistance .....</b>              | <b>3</b>  | <b>Recording .....</b>             | <b>24</b> |
| <b>First-Time Operation .....</b>    | <b>3</b>  | Time-Remaining Display .....       | 24        |
| <b>Power Your Camcorder .....</b>    | <b>12</b> | Select a Tape Length .....         | 24        |
| Adapter/Charger .....                | 12        | Recording Tips .....               | 26        |
| Rechargeable Battery .....           | 13        | Use the Viewfinder to See What You |           |
| Charge the Battery .....             | 14        | Record .....                       | 27        |
| Battery Level Indicator .....        | 15        | Eyepiece Focus Control .....       | 27        |
| Battery Care and Storage .....       | 15        | Viewfinder Displays .....          | 28        |
| Optional Car Cord Adapter .....      | 16        | AutoShot™ Mode .....               | 32        |
| <b>Date and Time Display .....</b>   | <b>17</b> | Five-Second Record Feature .....   | 33        |
| Install the Clock Lithium Cell ..... | 17        | Quick Review Feature .....         | 33        |
| Set the Date and Time .....          | 18        | Camera Edit Feature .....          | 33        |
| Record AUTO DATE, Date, Time, and    |           | .....                              | 33        |
| Title Displays .....                 | 20        | Flying Erase Head .....            | 33        |
| .....                                |           | .....                              | 33        |
| <b>Videocassettes .....</b>          | <b>22</b> | MENU/DISPLAY Button .....          | 33        |
| Erase Protection – Safety Tab .....  | 22        | Zooming .....                      | 34        |
| Recording and Playback Speeds and    |           | Use the Zoom Lever (W and T) ..    | 34        |
| Times .....                          | 22        | Digital Zooming .....              | 34        |
| Insert and Remove Cassettes .....    | 23        | Tele Macro Zooming .....           | 35        |
| Cassette Care and Storage .....      | 23        | Focusing .....                     | 36        |
|                                      |           | Auto Focus .....                   | 36        |
|                                      |           | Manual Focus .....                 | 37        |

# Table of Contents

## **Recording (Cont.)**

|                                    |    |
|------------------------------------|----|
| White Balance .....                | 38 |
| Auto White Balance .....           | 38 |
| Manual White Balance .....         | 38 |
| Exposure Control .....             | 40 |
| Auto Exposure .....                | 40 |
| Manual Exposure .....              | 40 |
| Steady Pix™ Feature .....          | 41 |
| Fade or Wipe In or Out .....       | 42 |
| P. (Program) AE Button .....       | 44 |
| 16X9 Mode .....                    | 45 |
| Preset Titles .....                | 46 |
| Select a Language for the Title .. | 46 |
| Record a Preset Title .....        | 47 |
| Animation Recording .....          | 48 |
| Time-Lapse Recording .....         | 50 |
| Demo Mode .....                    | 52 |
| Attach the Shoulder Strap .....    | 53 |

## **Playback .....** 55

|  |    |
|--|----|
| Use the Viewfinder for Playback ..                       | 55 |
| Playback Features .....                                  | 56 |
| Position the Tape .....                                  | 56 |
| Visual Search .....                                      | 56 |
| Stop-Action Pause .....                                  | 56 |
| Time Counter .....                                       | 57 |
| Tracking .....   | 57 |
| TBC (Time Base Corrector) .....                          | 57 |
| Use the Cassette Adapter .....                           | 58 |
| Playback on TV (or VCR) with<br>Audio/Video Inputs ..... | 60 |

## **Optional Accessories .....** 62

|  |    |
|--|----|
| Using the Optional AC088 Tripod                | 64 |
| Order Form for Camcorder Model<br>CC6263 ..... | 65 |

## **Trouble Checks .....** 68

## **Specifications .....** 72

## **Care and Maintenance .....** 73

|                                  |    |
|----------------------------------|----|
| Clean the Camcorder .....        | 73 |
| Clean the Camcorder's Lens ..... | 73 |
| Clean the Camcorder's Viewfinder | 73 |
| Proper Care and Storage .....    | 74 |
| Things to Avoid .....            | 74 |

## **Customer Assistance and Service**75

## **Limited Warranty .....** 76

## **Index .....** 78

# First-Time Operation

This section describes the steps necessary to set up your camcorder to record. Refer to the other sections for detailed operation and feature options.

## Assistance

The toll-free numbers are available to help you with any problem you may encounter.

Camcorder Exchange Warranty.....800-283-6503  
Customer Service..... 800-336-1900  
Accessories..... 800-338-0376

## 1. Unpack the camcorder and accessories.

- Save the packing materials and box in case you ever need to ship or store your camcorder.
- The items shown below are packed with your camcorder. If any are missing or appear damaged, contact your dealer immediately.

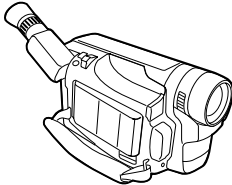

Model CC6263  
Camcorder

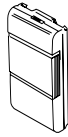

Rechargeable Battery  
Part No FB1260

**WARNING:**  
NICKEL  
CADMIUM  
BATTERY  
MUST BE  
RECYCLED  
OR DISPOSED  
OF PROPERLY.

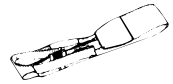

Shoulder Strap  
Part No. ACS091



AC Adapter/Charger -- Part No. 242740  
and DC Cable -- Part No. 244268

**Caution:** Do not use this adapter/charger for any purpose other than charging the FB1260, or BB99L battery pack or supplying power to the camcorder.

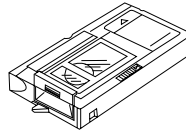

Cassette Adapter  
Part No. VCA115

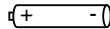

Cassette Adapter Battery  
(Size "AA" 1.5 Volt)



**Clock Cell**  
3-Volt Micro Lithium Cell – such as CR2025 – available from most local drug stores and camera shops. Use of other cells present a risk of fire or explosion.

**CAUTIONS:** Lithium cell must be disposed of properly. Never handle punctured or leaking cell. May cause burns or personal injury. Keep out of the hands of children. Can cause death or injury if swallowed. If swallowed, consult a physician immediately for emergency treatment. The lithium cell used in this device may explode resulting in a fire or chemical burn if mistreated. Do not recharge, disassemble, heat above 212°F (100°C), or incinerate. Never use metallic tweezers to hold the cell, and never short circuit the + and – sides of the cell.

*(continues on next page)*

# First-Time Operation

(continued from previous page)

## 2. Attach the adapter/charger.

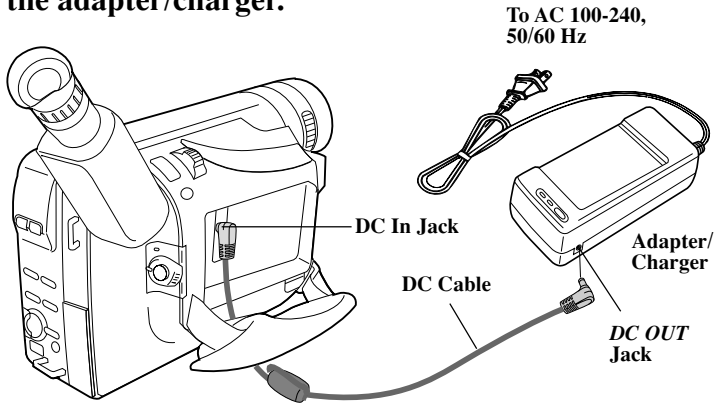

Since the battery must be charged before it can be used the first time, attach the adapter/charger to the camcorder.

- Connect one end of the DC cable to the *DC OUT* jack on the adapter/charger.
- Connect the other end of the DC cable to the DC in jack on the camcorder *as shown above*.
- Plug the adapter/charger's plug into an operating outlet.

## 3. Adjust the handstrap to fit your hand.

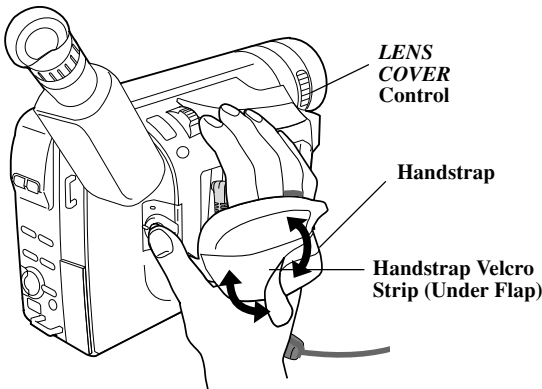

- Lift the flap on the handstrap and separate the velcro strip.
- Insert your hand, adjust the strap to fit snugly, refasten the strap, and close the flap.

## 4. Rotate *LENS COVER* control to open lens cover.

# First-Time Operation

## 5. Set **POWER (CAMERA MAN/CAMERA AUTO/OFF/VCR)** switch to **CAMERA AUTO**.

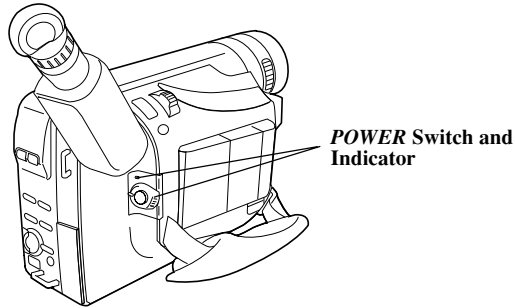

- The power indicator lights.
- The position of this switch tells the camcorder whether you want to record (**CAMERA MAN** or **CAMERA AUTO**), turn the power off (**OFF**), or play back tapes (**VCR**).
- **CAMERA AUTO** places the camcorder in the AutoShot™ mode. In the AutoShot™ mode, the focus, exposure, and white balance are automatically controlled by the camcorder. Many of the special effects do not operate in this mode. *Details on page 32.*
- **CAMERA MAN** allows you to control many of the special features of the camcorder.
- The camcorder automatically turns off if it remains in record-pause for five minutes. Set the **POWER** switch to **OFF** and then back to **CAMERA**.

## 6. Adjust the viewfinder and eyepiece focus control.

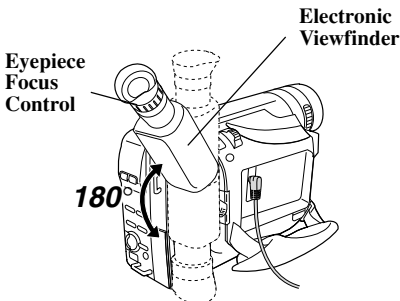

You can see what you record in the viewfinder.

- Adjust the viewfinder for a comfortable viewing position.
- Turn the eyepiece focus control to adjust the focus of the viewfinder for your vision.

*(continues on next page)*

# First-Time Operation

(continued from previous page)

## 7. Insert a tape.

### WARNING:

Never try to open the door by prying as you could damage the camcorder.

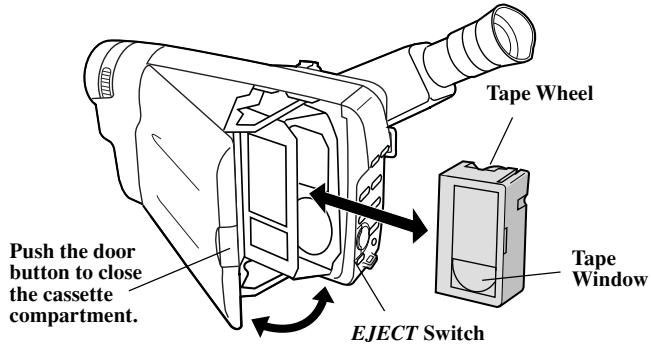

- Slide the *EJECT* switch. The cassette holder opens automatically.
- Turn the tape wheel on the cassette to remove any slack from the tape.
- Insert the cassette with the tape wheel facing up and the tape window facing out.
- Press the button on the cassette door to close the compartment until the cassette holder locks into place.
- The camcorder enters record-pause.  $\equiv$  PAUSE  $\equiv$  appears in the viewfinder when the camcorder is in record-pause.

## 8. Select a recording speed.

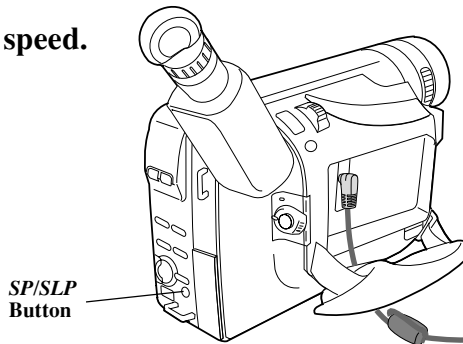

Select SP or SLP recording speed. Press and hold the *SP/SLP* button to select a recording speed. The tape speed you select (*SP* or *SLP*) appears in the viewfinder.

- *SP* – Standard play provides the best picture, but the shortest

recording time (20 minutes with a TC-20 tape).

- *SLP* – Extended play provides three times the recording time as *SP* (60 minutes with a TC-20 tape). *SLP* has slightly more picture noise in normal playback.



# First-Time Operation

## 9. Select a tape length.

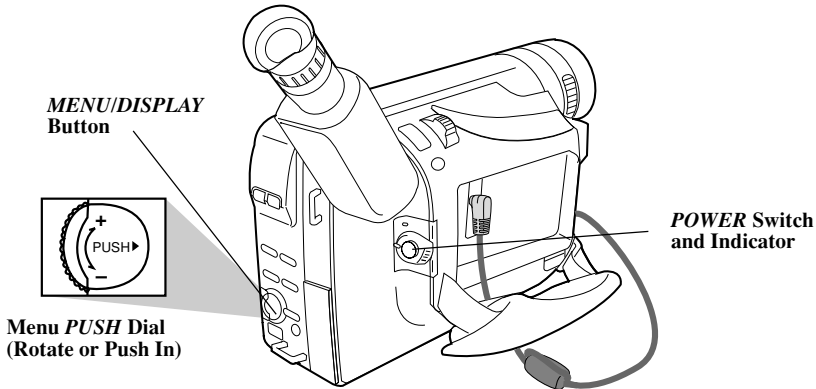

1. Set the *POWER* switch to *CAMERA MAN*.
2. Press the *PUSH* dial in to display the menu in the viewfinder.

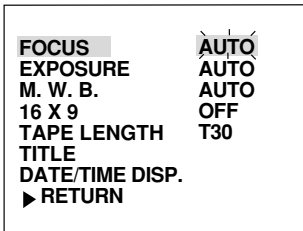

3. Rotate the menu *PUSH* dial to highlight *TAPE LENGTH*.

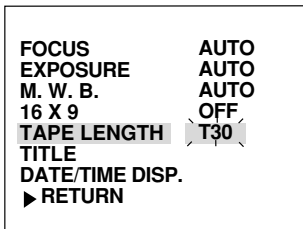

4. Press the *PUSH* dial in to display the *TAPE LENGTH* menu.

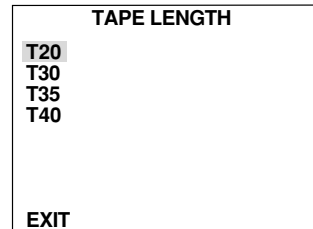

5. Rotate the menu *PUSH* dial to highlight the type of tape you are using.

- Select *T20* for a tape with 20 minutes or less recording time in SP
- Select *T30* for a tape with 30 minutes recording time in SP
- Select *T35* for a tape with 35 minutes recording time in SP
- Select *T40* for a tape with 40 minutes recording time in SP

6. Press the menu *PUSH* dial **twice** to select the tape length and remove the menus from the viewfinder.

- *Details are on pages 24-25.*

*(continues on next page)*

# First-Time Operation

(continued from previous page)

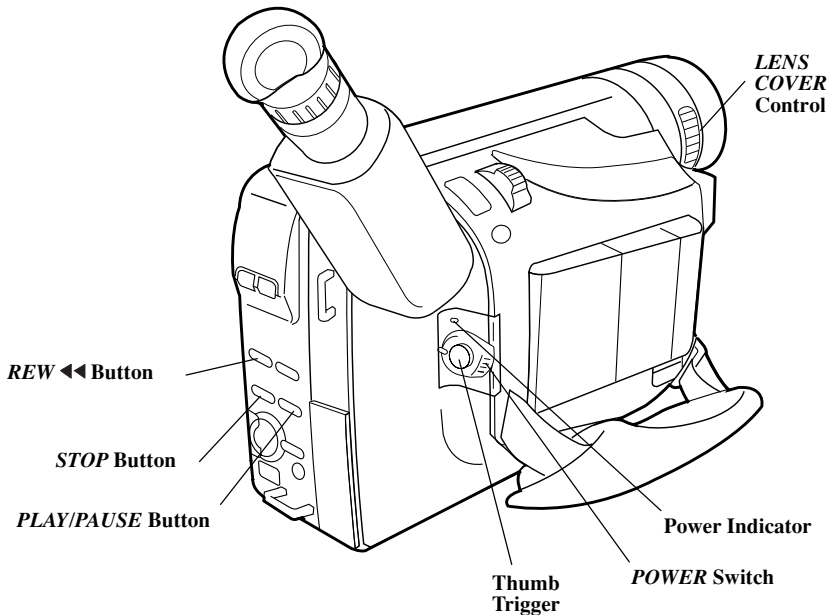

## 10. Start and stop recording.

- Place the *POWER* switch in *CAMERA AUTO*.
- Press and release the thumb trigger to start recording. **REC** appears in the viewfinder while the camcorder is recording.
- Press and release the thumb trigger again to stop recording. The camcorder is now in the record-pause mode. **≡PAUSE≡** appears in the viewfinder.

## 11. Play back what you have recorded.

- Set the *POWER* switch to *VCR*.
- Press *REW* << to rewind the tape.

- Press *PLAY/PAUSE* to play back the tape.
- Press *STOP* when you are finished playing back the tape.
- *Details on viewfinder playback are on page 55.*

## 12. Set the *POWER* switch to *OFF* to turn off the camcorder.

The power indicator turns off.

## 13. Close the lens cover.

# First-Time Operation

## 14. Review camcorder operating controls.

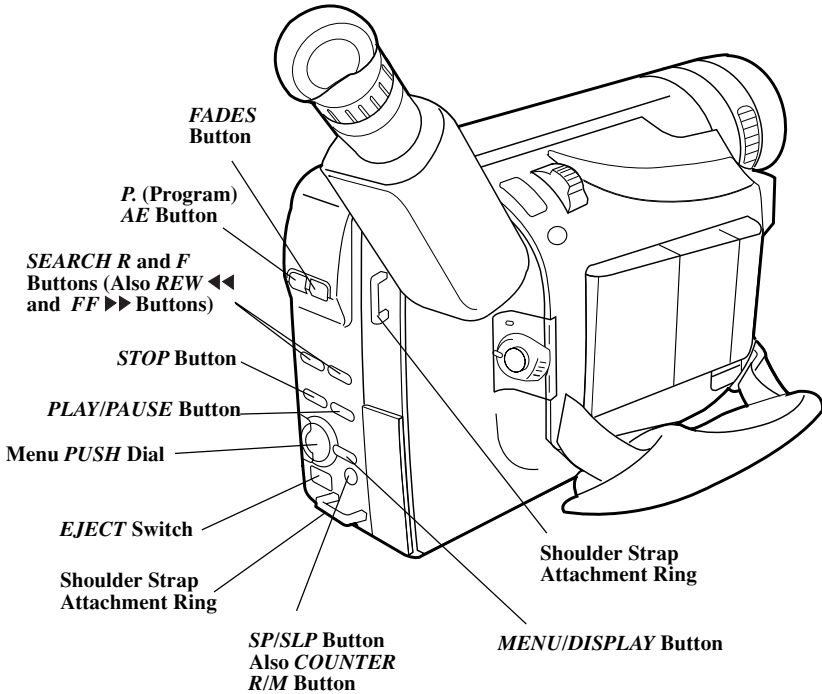

(continues on next page)

# First-Time Operation

(continued from previous page)

## 14. Review camcorder's operating controls. (Continued)

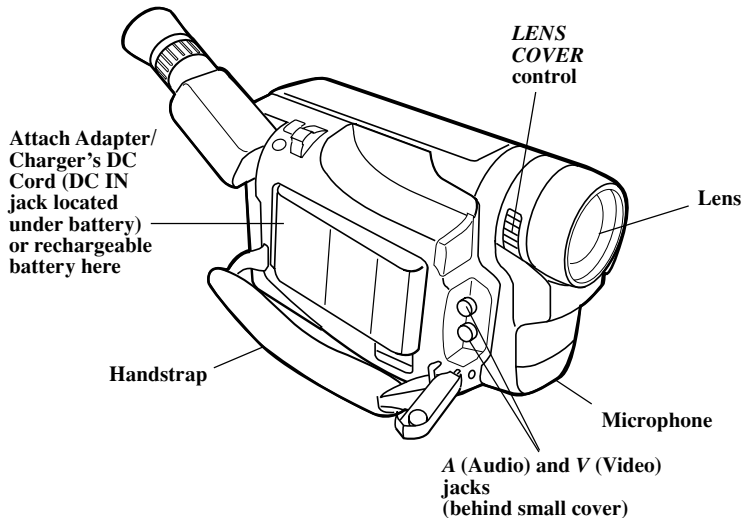
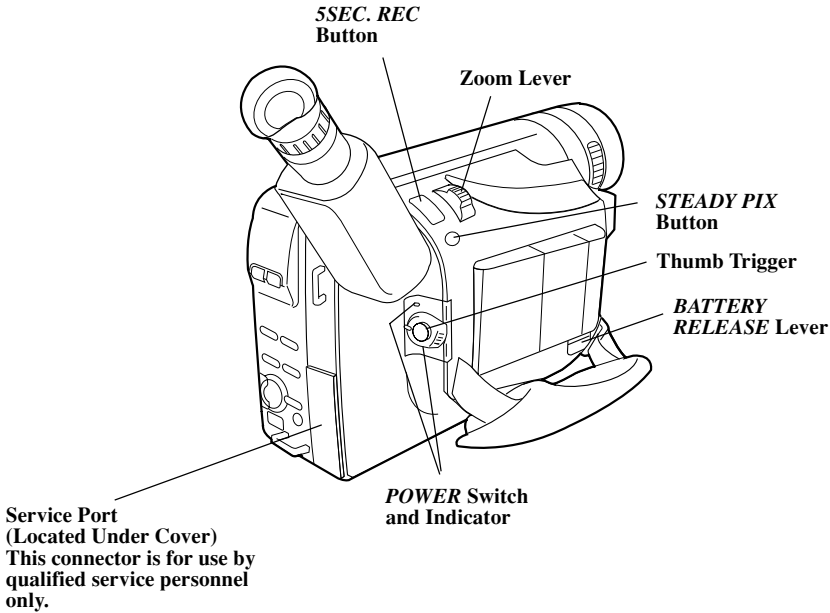

# First-Time Operation

## 14. Review camcorder's operating controls. *(Continued)*

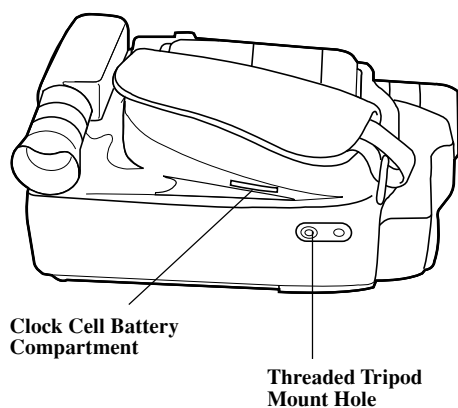
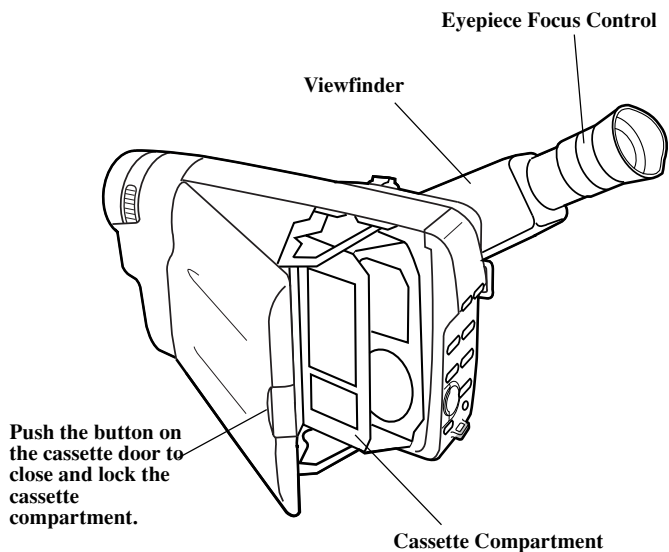

# Power Your Camcorder

## Adapter/Charger

The adapter/charger attaches to the camcorder and lets you power your camcorder directly from standard household power. The adapter/charger operates on 100-240 volts, 50/60 Hz, so it can be used virtually anywhere in the world to power the camcorder or recharge the battery.

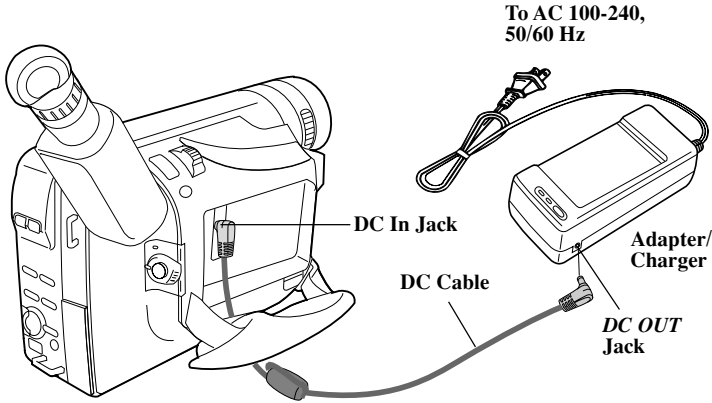

## Attach Adapter/Charger

1. Connect one end of the DC cable to the *DC OUT* jack on the adapter/charger.
2. Connect the other end of the DC cable to the DC in jack on the camcorder *as shown above*.
3. Plug the adapter/charger's plug into the nearest AC outlet (100-240V, 50/60Hz).

**CAUTION:** Do not use this adapter/charger for any other purpose other than charging the FB1260 or BB99L battery pack or supplying power to the camcorder.

## Remove Adapter/Charger

1. Unplug the adapter/charger from the wall outlet.
2. Remove the DC cable from the adapter/charger and camcorder.

## Using an Optional Plug Adapter

An optional plug adapter might be required in some countries.

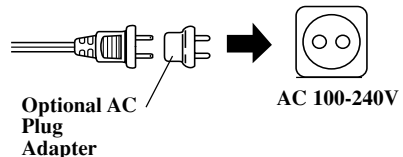

1. Plug the adapter/charger's plug into the AC plug adapter.
2. Plug the AC plug adapter into the AC outlet.

# Power Your Camcorder

## Rechargeable Battery

The battery must be charged *as described on the next page* before it can be used the first time. Initial charging takes approximately 70 minutes. When fully charged, the battery supplies approximately 95-105 minutes of operating time – depending on how much you use zoom and pause. Conserve battery power by turning the camcorder off during recording breaks.

**Note:** Use the small marker switch on the top of the battery to help remind yourself to charge the battery. It has no other purpose.

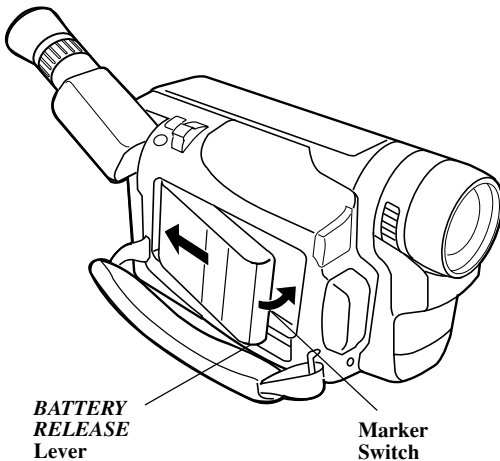

### Battery Safety Precautions

Do not short the battery's terminals.

Do not attempt to disassemble or modify the battery. There are no user-serviceable parts inside.

Use the battery only with specified adapter/chargers and camcorders.

Throwing the battery into a fire or exposing it to excessive heat – over 149°F (65°C) could be hazardous.

## Attach the Charged Battery

If the DC cable is attached to the camcorder, remove it before attaching the battery. Also, install the lithium clock cell before attaching the battery.

*Details are on page 17.*

1. Hook the battery to the side of the camcorder *as shown above*.

2. Press the battery down until it locks into place.
3. Set the **POWER** switch to **CAMERA**. The power indicator lights.

## Remove the Battery

Slide and hold the **BATTERY RELEASE** lever down while removing the battery.

**ATTENTION:** The EPA certified RBRC® Battery Recycling Seal on the nickel-cadmium (Ni-Cd) battery indicates Thomson Consumer Electronics is voluntarily participating in an industry program to collect and recycle these batteries at the end of their useful life, when taken out of service in the United States or Canada. The RBRC® program provides a convenient alternative to placing used Ni-Cd batteries into the trash or the municipal waste stream, which may be illegal in your area. Please call 1-800-8-BATTERY™ for information on Ni-Cd battery recycling and disposal bans/restrictions in your area. Thomson Consumer Electronics' involvement in this program is part of our commitment to preserving our environment and conserving our natural resources.



# Power Your Camcorder

## Use the Battery to Power Your Camcorder

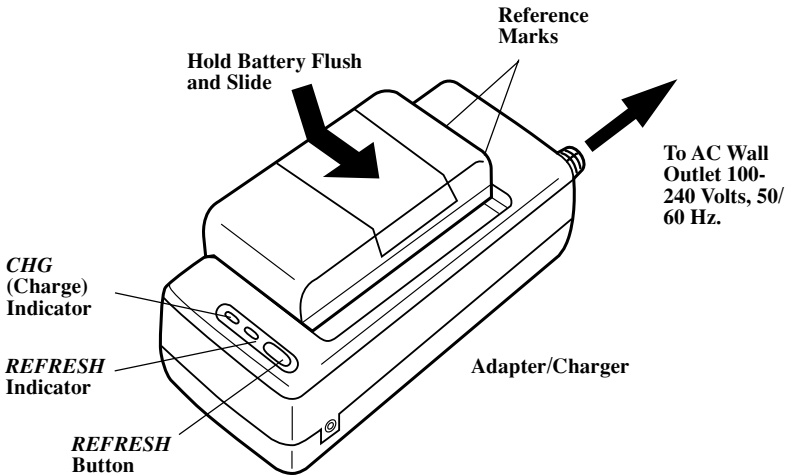

**Caution:** When a battery is attached to the adapter/charger, do not turn them upside down. The battery may fall off and be damaged or cause injury.

## Charge the Battery

If the DC cable is attached to the *DC OUT* jack on the adapter/charger, remove it.

1. Align reference mark on battery with mark on adapter/charger.
2. Hold the battery flush against the adapter/charger and slide it in the direction of the arrow.
3. Plug adapter/charger into nearest AC outlet (100-240V, 50/60Hz).
4. If the battery is properly connected, the *CHG* indicator flashes.

**Note:** If you try to charge a battery that has not been charged for a long period of time, it may take a few minutes for the *CHG* indicator to flash.

5. After the battery is charged, the *CHG* indicator stops flashing and lights.

6. Remove the charged battery by sliding it off the adapter/charger.
7. Attach the charged battery to the camcorder.

## Use the *REFRESH* Button

The battery provides increased operation time if you “refresh” it after five chargings. The refresh feature “refreshes” the battery by completely discharging it.

1. Attach battery to adapter/charger.
2. Press *REFRESH*. The *REFRESH* indicator lights and the battery begins discharging.
3. When discharging is completed, the *REFRESH* indicator turns off, and the *CHG* indicator flashes. The battery now charges.



# Power Your Camcorder





## Use the Battery to Power Your Camcorder (Continued)

4. After the battery is charged, the *CHG* (charge) indicator stops flashing and lights.
5. Remove the battery from the adapter/charger.

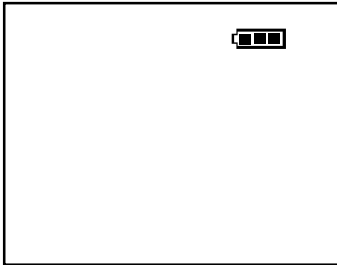
### Battery Level Indicator

The battery level indicator appears in the viewfinder and shows you the amount of power in the rechargeable battery.



- When  appears, the battery is fully charged.
- As the power is used  and  appear.
- When the battery power is almost gone,  flashes in the viewfinder. The camcorder turns off automatically after a few seconds. Set the *POWER* switch to *OFF* to turn off the camcorder before replacing the battery.

The battery level indicator is not recorded on the tape.

### Battery Care and Storage

- Recharging takes approximately 70 minutes for the battery depending on the battery's condition.
- Refreshing takes approximately 3-1/2 hours for the battery depending on the battery's condition.
- After repeated charging and use, operation time gradually decreases. When operation time is too short to be useful, it is time to replace the battery.
- If the battery discharging must be stopped in the middle, remove the battery from the adapter/charger before unplugging it from the AC outlet.
- If the battery pack becomes too hot, remove it from the charger and let it cool down.
- Let a hot battery cool down before attaching it to the AC adapter/charger.

# Power Your Camcorder

## Optional Car Cord Adapter

The optional DCC08 car cord *shown on page 62* allows you to power your camcorder from the cigarette lighter socket of a car, truck, or RV. It converts 12-volts to a 6-volt output.

**Note:** Consult the installation and operating instructions enclosed with the DCC08 for complete operating instructions.

**Cautions:** The DCC08 is designed to be used only with vehicles having negative ground electrical systems.

Use only car cord adapter DCC08 with this camcorder. Use of any other car cord adapter might damage the camcorder and void your warranty.

## Use the DCC08 Car Cord Adapter

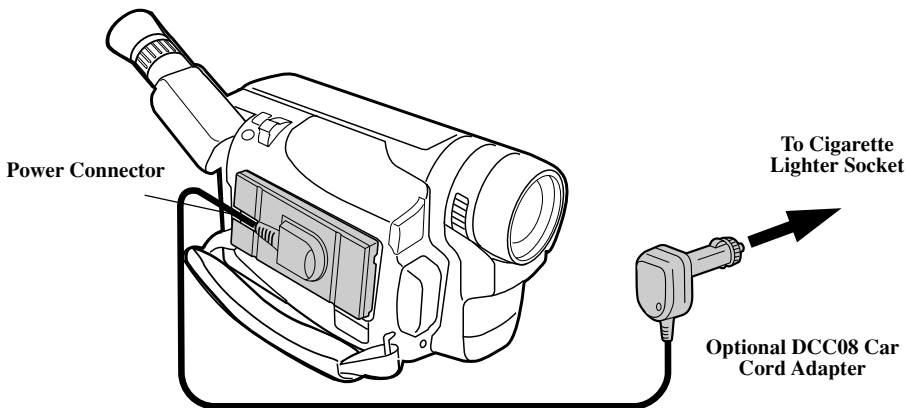

1. Set the *POWER* switch to *OFF* to turn off the camcorder. The power indicator on the camcorder turns off.
2. If the battery or DC cable is attached to the camcorder, remove it.
3. Hold the bottom of the power connector flush against the camcorder, and press the connector down until it locks into place *as shown above*.
4. Take the vehicle's cigarette lighter out of the socket.
5. Insert the car cord's cigarette lighter plug into the vehicle's cigarette lighter socket. The power indicator on the car cord adapter lights.
6. Set the *POWER* switch to *CAMERA* to turn on the camcorder. The power indicator on the camcorder lights.

**Caution:** Make sure the camcorder's power is turned off before removing the car cord's plug from the cigarette lighter socket.

## Install the Clock Lithium Cell

The clock cell indicator  flashes for a few seconds in the viewfinder when you turn on the camcorder if the cell is not installed or needs replacing.

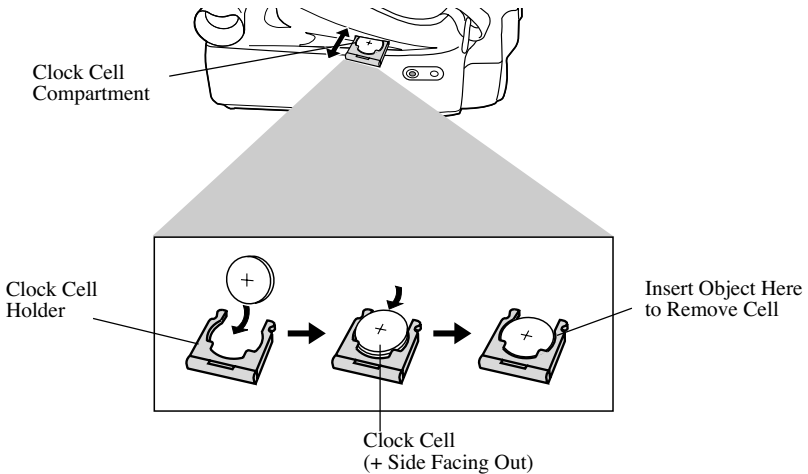

1. Make sure camcorder is turned off, and remove any power supply attached to the camcorder.
2. Pull the clock cell holder out of the clock cell compartment.
3. Insert the clock cell with the “+” terminal facing out, and press it in.
4. Place the clock cell holder into the clock cell compartment. Be sure to insert the holder fully into the compartment.

### To Remove Lithium Cell

To remove battery, insert a pointed nonmetallic object between battery and clock cell holder and lift.

**Cautions:** Lithium cell battery. Replace only with 3-volt lithium cell – such as CR2025. Use of other cell presents a risk of fire or explosion. Must be disposed of properly. Never handle punctured or leaking cell. May cause burns or personal injury.

Keep out of the hands of children. Can cause death or injury if swallowed. If swallowed, consult a physician immediately for emergency treatment.

The lithium cell used in this device may explode resulting in a fire or chemical burn if mistreated. Do not recharge, disassemble, heat above 212°F (100°C), or incinerate.

Never use metallic tweezers to hold the cell, and never short the + and – sides of the cell.

# Date and Time Display

## Set the Date and Time

You must set the correct date and time before you can display and record it on your tapes. The clock cell must be installed *as shown on the previous page* before you can set the date.

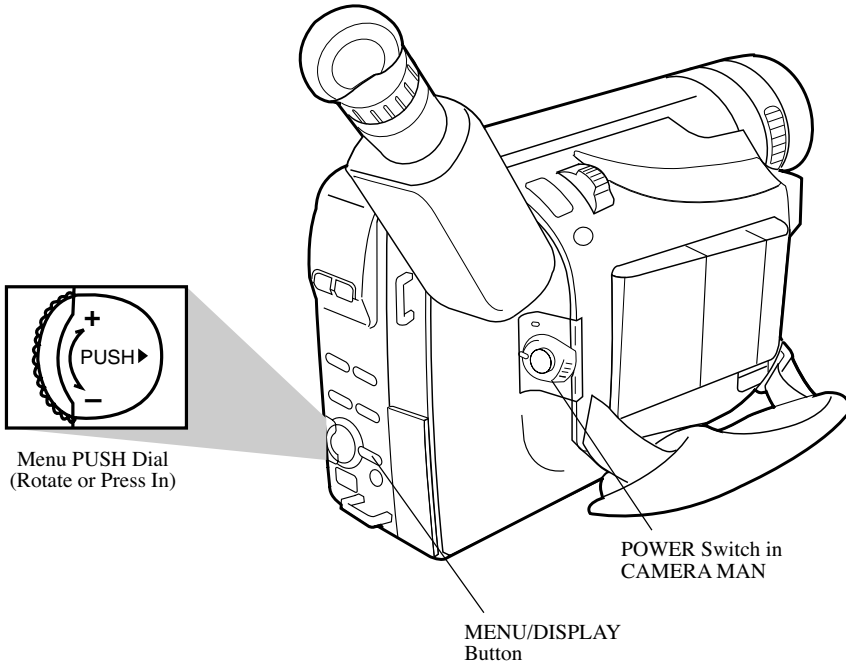

1. Set the *POWER* switch to *CAMERA MAN*.
2. Press the *MENU/DISPLAY* button to display the menu in the viewfinder.

3. Rotate the menu *PUSH* dial to highlight *DATE/TIME*.

|                    |  |
|--------------------|--|
| <b>D. ZOOM</b>     | <input checked="" type="checkbox"/> ON |
| <b>TELE MACRO</b>  | <input type="checkbox"/> OFF           |
| <b>REC TIME</b>    | <input type="checkbox"/> OFF           |
| <b>INT. TIME</b>   | <input type="checkbox"/> OFF           |
| <b>DATE/TIME</b>   |  |
| <b>TITLE LANG.</b> | ENGLISH                                |
| <b>DEMO MODE</b>   | <input type="checkbox"/> OFF           |
| <b>▶ RETURN</b>    |  |

|                    |                              |
|--------------------|------------------------------|
| <b>D. ZOOM</b>     | <input type="checkbox"/> ON  |
| <b>TELE MACRO</b>  | <input type="checkbox"/> OFF |
| <b>REC TIME</b>    | <input type="checkbox"/> OFF |
| <b>INT. TIME</b>   | <input type="checkbox"/> OFF |
| <b>DATE/TIME</b>   |                              |
| <b>TITLE LANG.</b> | ENGLISH                      |
| <b>DEMO MODE</b>   | <input type="checkbox"/> OFF |
| <b>▶ RETURN</b>    |                              |

# Date and Time Display

## Set the Date and Time (Continued)

4. Press the menu *PUSH* dial in to display the *DATE/TIME* menu.

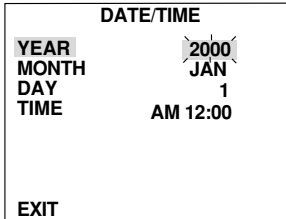

5. Rotate the menu *PUSH* dial to highlight *YEAR*. Press the menu *PUSH* dial in. When *YEAR* starts flashing, rotate the menu *PUSH* dial to select the year. When the correct year appears, press the menu *PUSH* dial in to set the year.
6. Repeat step 5 to set the *MONTH* and *DAY*.
7. Rotate the menu *PUSH* dial to highlight *TIME*.

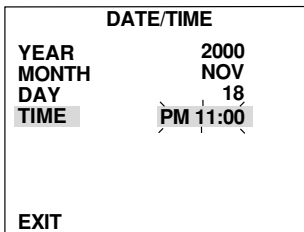

8. Press the menu *PUSH* dial in. When the hour starts flashing, rotate the menu *PUSH* dial to set the hour including *AM* or *PM*.
9. Press the menu *PUSH* dial in. When the hour stops flashing and the minutes start flashing, rotate the menu *PUSH* dial to set the minutes.

10. Press the menu *PUSH* dial in. When none of the settings are flashing, rotate the menu *PUSH* dial to highlight *EXIT*.

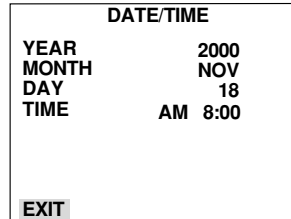

11. Press the menu *PUSH* dial *twice* to remove the menus from the viewfinder.

---

**Notes:** If you decide to return the date and time to the previous settings while the *DATE/TIME* menu is displayed, rotate the menu *PUSH* dial to highlight *EXIT*, and press. Press the menu *PUSH* dial again to remove the menus from the viewfinder.

To display and record the date and/or time, see the following pages.

# Date and Time Display

## Record *AUTO DATE*, Date, Time, and Title Displays

You must install the clock cell and set the date and time (*as shown on the previous pages*) before the you can select and record the correct date and time.

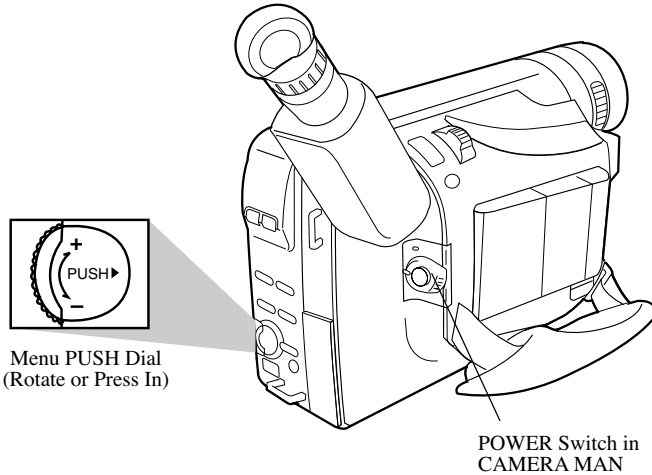

## Select *AUTO DATE*, Date, Time, or Date and Time to Record on Your Tape

1. Attach a power supply and set *POWER* switch to *CAMERA MAN*.  
The power indicator lights.  
**Note:** *AUTO DATE* is selected when the *POWER* switch is set to *CAMERA AUTO*.
2. Press the menu *PUSH* dial in to display the menu in the viewfinder.

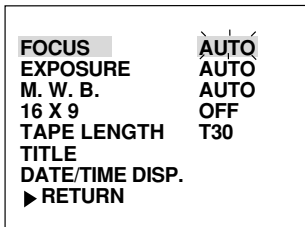
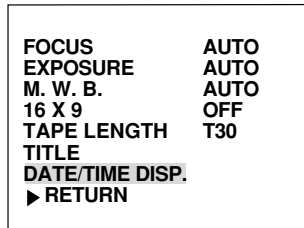

4. Press the menu *PUSH* dial in to display the *DATE/TIME DISP.* menu.

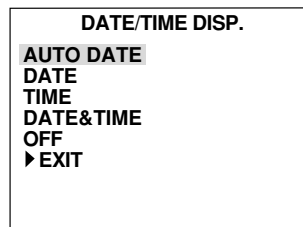

3. Rotate the menu *PUSH* dial to highlight *DATE/TIME DISP.*

# Date and Time Display

## Record *AUTO DATE*, Date, Time, and Title Displays (Continued)

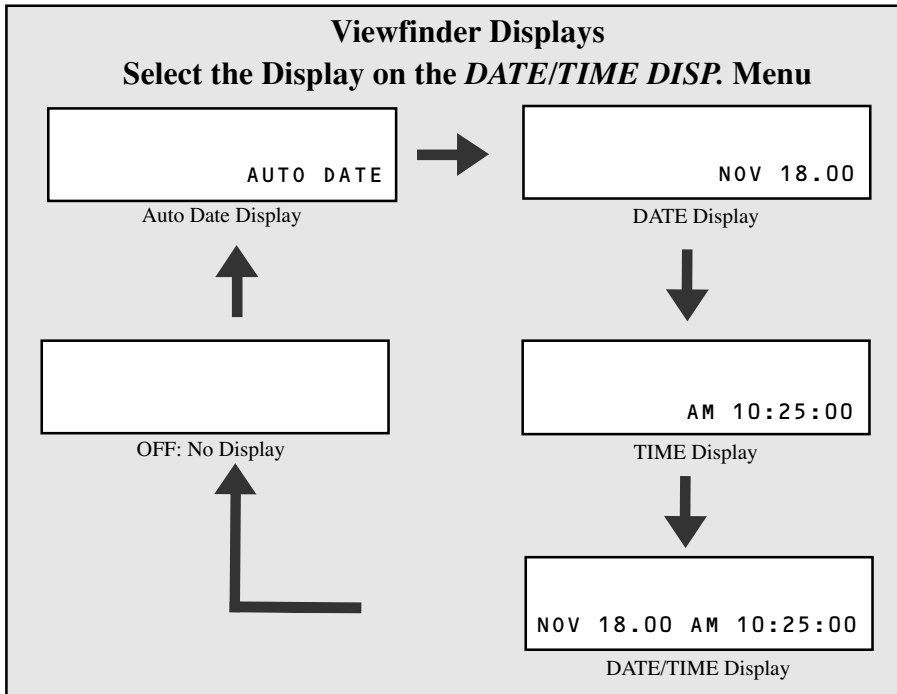

5. Rotate the menu *PUSH* dial to highlight the date/time display you want to record
  - ***AUTO DATE***: The date is automatically recorded for approximately five seconds and then *AUTO DATE* is displayed whenever:
    - The date is set or changed.
    - This display mode is selected.
    - The tape is changed or the tape compartment opened.
    - This display is selected whenever the *POWER* switch is set to *CAMERA AUTO*.
  - ***DATE Display***: The date is displayed and recorded.
  - ***TIME***: The time is displayed and recorded.
  - ***DATE/TIME Display***: The date and time are displayed and recorded.
  - ***OFF***: No display is displayed or recorded.
6. Press the select *PUSH* dial in to select the date/time display you want to record.
7. Press the menu *PUSH* dial in to remove the menu from the viewfinder.
8. Press the thumb trigger to begin recording.

## Videocassettes

Make sure you select good quality tapes for your camcorder. Use of poor quality tapes or tapes that have been damaged or mishandled can contaminate the video heads, resulting in a snowy picture or no picture at all during playback. Because there is no control over the type of tape purchased or rented by consumers, head cleaning is not covered under warranty. It is considered normal maintenance.

### Erase Protection – Safety Tab

You can use your videocassettes over and over again. To erase a previous recording, just record over it.

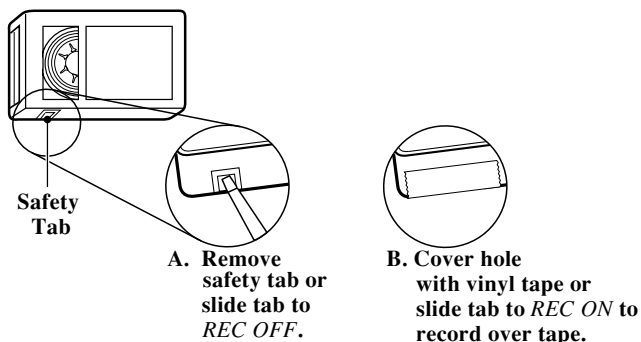

### Recording and Playback Speeds and Times

The camcorder records and plays back in standard speed (SP) or extended play (SLP). Select the recording speed by pressing *and holding* the *SP/SLP* button. The selected speed is displayed in the viewfinder. Listed below are the maximum SP and SLP recording times for popular VHS-C cassettes.

- SP – Standard play provides the best picture (less picture noise), but the shortest recording time (20 minutes with a TC-20 tape).
- SLP – Extended play provides three times the recording time as SP (60 minutes with a TC-20 tape). SLP has slightly more picture noise than SP in normal playback. This might not be noticeable.

| Cassette | Recording Time |          |
|----------|----------------|----------|
|          | SP             | SLP      |
| TC-20    | 20 Min.        | 60 Min.  |
| TC-30    | 30 Min.        | 90 Min.  |
| TC-35    | 35 Min.        | 105 Min. |
| TC-40    | 40 Min.        | 120 Min. |



# Videocassettes

## Insert and Remove Cassettes

### Warning:

Never try to open the door by prying as you could damage the camcorder.

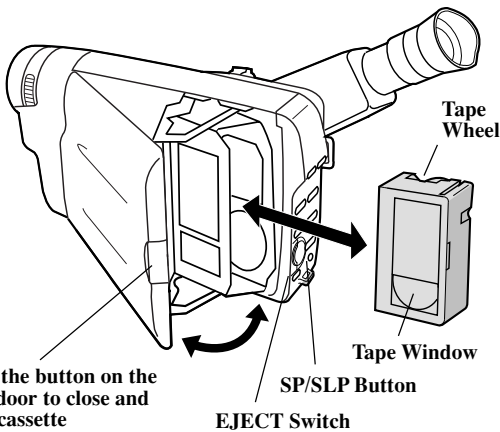

Press on the button on the cassette door to close and lock the cassette compartment.

### CAUTION:

Insert the cassette only one way with the tape wheel facing up and the tape window facing out. The cassette should slide easily into the holder. Do not force the cassette.

Before inserting a cassette, turn the tape wheel on the side of the cassette in the direction shown to remove any slack in the tape.

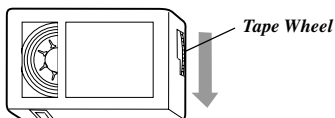

1. Slide the *EJECT* switch. The cassette holder opens automatically.
2. Insert the cassette with the tape wheel facing up and tape window facing out.
3. Press on the cassette door button until the cassette holder locks into place.

## Cassette Care and Storage

- When you are finished with a cassette, rewind it, remove it from the camcorder, and label it.
- Store cassettes vertically in their protective cases at normal room temperatures. Do not leave your camcorder or cassettes in a car or outdoors for an extended period. Excessive heat or cold might damage your cassettes.
- Keep the cassette away from strong magnetic fields such as electric motors and other devices.
- Keep dust from entering the cassette compartment. All dust is abrasive and causes excessive wear on the tape and the camcorder's recording or playback heads.
- Do not use cassettes with damaged or spliced tape.
- Do not use a cassette if it has been damaged or exposed to moisture. The tape might jam and/or damage your camcorder.

# Recording

## Time-Remaining Display

The approximate time remaining on the tape in the camcorder for the tape speed you select is displayed. You must set the correct tape length in the *TAPE LENGTH* feature of the menu before the camcorder can correctly calculate time remaining.

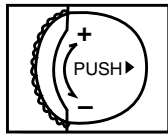

**Menu PUSH Dial**  
(Rotate or Press In)

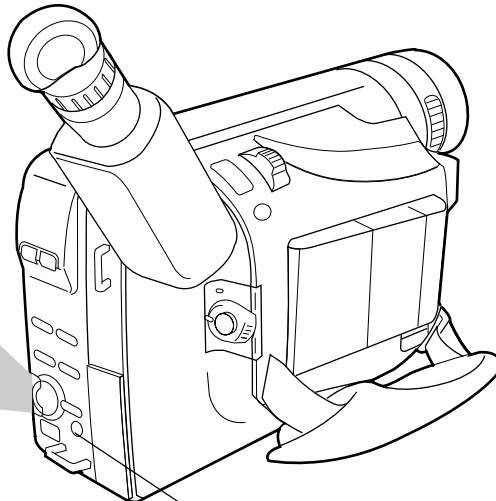

**SP/SLP**  
**Button**

## Select a Tape Length

1. Set the *POWER* switch to *CAMERA MAN*.
2. Press *and hold* the *SP/SLP* button to select a tape speed.
3. Press the *PUSH* dial in to display the menu in the viewfinder.
4. Rotate the menu *PUSH* dial to highlight *TAPE LENGTH*.

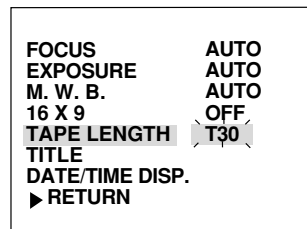
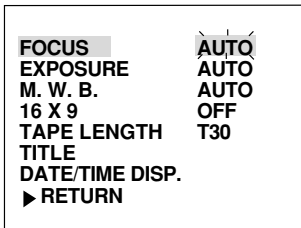

5. Press the menu *PUSH* dial in to display the *TAPE LENGTH* menu.

## Time-Remaining Display (Continued)

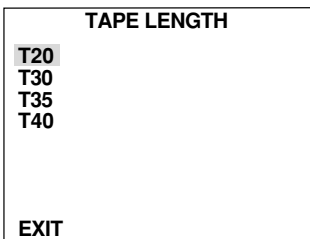
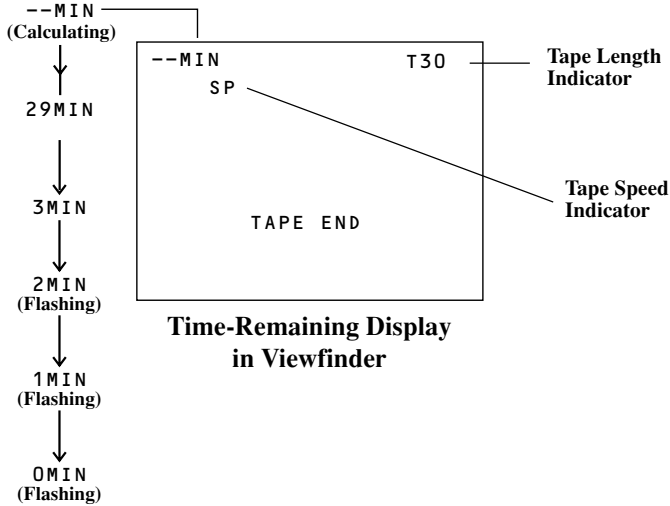

6. Rotate the menu *PUSH* dial to highlight the type of tape you are using.
  - Select *T20* for a tape with 20 minutes or less recording time in SP

- Select *T30* for a tape with 30 minutes recording time in SP
  - Select *T35* for a tape with 35 minutes recording time in SP
  - Select *T40* for a tape with 40 minutes recording time in SP
7. Press the menu *PUSH* dial **twice** to select the tape length and remove the menus from the viewfinder.

## Recording Tips

- Try to make sure indoor scenes are well-lit. This improves picture quality and color reproduction.
- Do not move the camcorder rapidly from side-to-side while recording. A steady gradual “pan” avoids blurring and “jitter”.
- Use the viewfinder to make sure the camcorder is level while recording so that your scene isn’t “tilted”.
- Do not bump or tap the camcorder’s microphone while recording because this sound is recorded.
- Include close-ups of individuals when taping family outings or group functions.
- Fading and wiping in and out of scenes makes your videos appear more professional.
- Learn to use the special *P. AE* production effects available with your camcorder to add variety to your recordings.
- Be aware of video and audio backgrounds. Background details barely noticed while you are taping may show up as visual “clutter” on your recording. Background noises (especially TV sets, radios, household appliances, traffic sounds, etc.) might detract from the sound you want to record.
- Avoid long “still” shots of landmarks and scenic attractions. Recordings are more interesting if they include people and details. “Local color” gives travel videos lasting appeal. Consider recording a familiar or landmark scene from an unfamiliar vantage point.

## Recording

### Use the Viewfinder to See What You Record

The camcorder's viewfinder is a miniature monitor that displays the picture seen by the camcorder when recording.

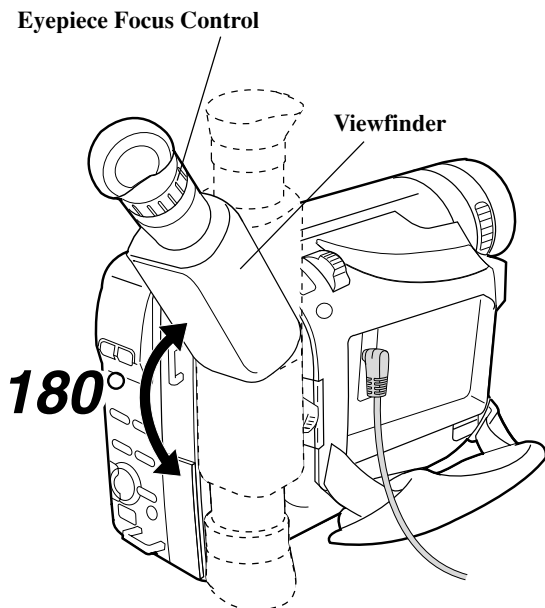

#### CAUTIONS:

Do not force the viewfinder to rotate completely around. This will damage the viewfinder and/or the camcorder.

When carrying the camcorder with the shoulder strap, put the viewfinder down and in to help prevent possible damage to the viewfinder from bumping against your body as you move.

### Adjust Viewfinder for Convenient Viewing

For convenient viewing, rotate the viewfinder up or down.

### Eyepiece Focus Control

The eyepiece focus control lets you set the focus of the viewfinder for your vision. If you wear eyeglasses, you probably can operate the camcorder without them.

It is easiest to set the correct focus by focusing on one of the viewfinder's on-

screen displays. Look through the viewfinder and adjust the eyepiece focus control for your vision.

The eyepiece focus control does not affect the focus of the picture actually recorded by the camcorder.

## Viewfinder Displays

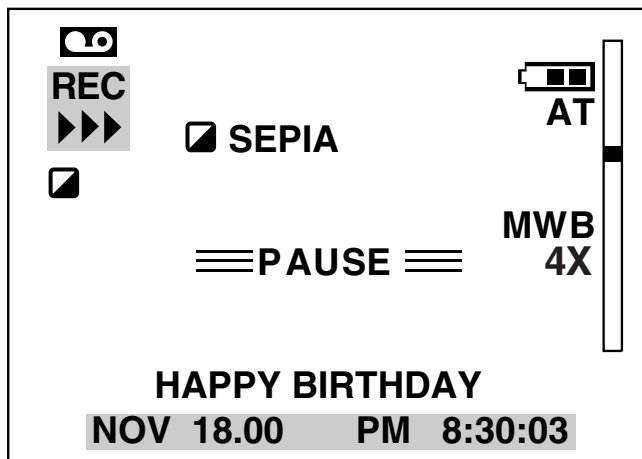

Several displays appear in the viewfinder to aid in the operation of the camcorder. You can press and *hold* the *MENU/DISPLAY* button for more than one second to remove or display the battery level indicator, tape-length indicator, and tape-remaining display.



### Battery Level Indicator ( )

- This indicator shows the amount of power left in the rechargeable battery.
- This indicator flashes when the battery is almost empty.

### Cassette Warning

- The  indicator flashes when the *POWER* switch is set to *CAMERA* and there is no cassette in the camcorder.
- The  indicator flashes when the *POWER* switch is set to *CAMERA* and the safety tab is set to *REC OFF* or removed from the cassette.

### *AUTO DATE*, Date, Time, or Date and Time

Display the *DATE/TIME DISP.* menu to display *AUTO DATE*, Date, Time, or the Date and Time.





- These displays are recorded when they are displayed. If you do not want to record one of them, select *OFF* in the menu.
- *Details are on pages 20-21.*

### *P. (Program) AE Button* Special Effect Indicators

-  *SEPIA*

This indicator appears when you select  *SEPIA* to give your recordings a brown-tone like old photographs.

## Viewfinder Displays (Continued)







-  **Sports**  
This indicator appears when you select  *SPORTS* to record fast-moving action, such as sporting events.
- **SD:SHADOW**  
This indicator appears when you select *SD:SHADOW* to darken the picture and reduce glare.
- **HZ:HAZE**  
This indicator appears when you select *HZ:HAZE* to soften the picture and give it a misty white effect.
-  **TWILIGHT**  
This indicator appears when you select *TWILIGHT* to record scenes at twilight, fireworks, etc.
-  **2 S 1/2000**  
This indicator appears when you select *1/2000* to record faster-moving action than the *SPORTS* mode.
-  **NEGA POSI**  
This indicator appears when you select *NEGA POSI* to reverse the colors and create a negative image.
- *Details are on page 44.*

### Preset Titles







- The preset title selected in the *TITLE* menu appears here. It will be recorded on the tape when it appears.
- *Details are on pages 46-47.*

### M. W. B. (Manual White Balance Indicators)

The indicator for the manual white balance selected in the *MWB* menu appears here.

-  appears when you select  *:FINE* to record outdoors on a sunny day.
-  appears when you select  *:CLOUD* to record outdoors on a cloudy day.
-  appears when you select  *:HALOGEN* to record using halogen or tungsten lighting.
- *MWB* appears when you select *MWB* to adjust the color temperatures.
- *Details are on pages 38-39.*

### Status Displays

- The  indicator appears when the camcorder is recording.
- The  indicator appears during record-pause.
-  appears when the camcorder plays back a tape.
-  appears during play-pause.
-  appears during fast forward and flashes during forward search.
-  appears during rewind and flashes during reverse search.

### (AT or MT) Tracking Indicator

- *AT* appears during automatic tracking.
- *MT* appears during manual tracking.

### Zoom Indicator (4X )

The zoom indicators  appear here when you use the zoom lever.

(continues on next page)

# Recording

(continued from previous page)

## Viewfinder Displays

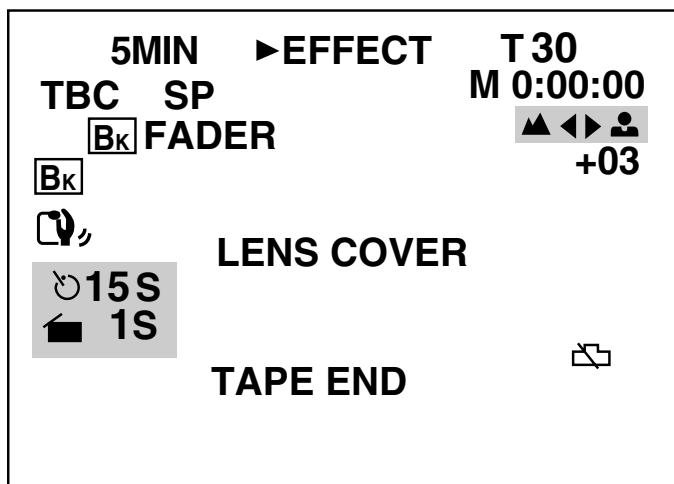

### Exposure Indicators (+03)

This indicator appears when you are adjusting brightness manually using the *EXPOSURE* menu. Make sure the *POWER* switch is set to *CAMERA MAN*.

- Details are on pages 40-41.

### Fade and Wipe Indicators (BK FADER)

Press the *FADES* button to display the indicator for the fade or wipe you want to select.

- BK FADER for black fade.
- MOSAIC for mosaic fade.
- SCROLL for scroll wipe.
- SLIDE for slide wipe.
- DOOR for door wipe.
- CW: CORNER for corner wipe.
- WW: WINDOW for window wipe.
- Details are on pages 42-43.

### Focus Indicators (▲◀▶●)

These indicators appear when you are adjusting focus manually using the *FOCUS* menu. Make sure the *POWER* switch is set to *CAMERA MAN*.

- The focus indicators (▲◀▶●) flash when the auto-focus system cannot operate properly.
- ▲ ● appear when you have selected *MENU* in the *FOCUS* menu.
- ✨ and ✨ flash while you adjust manual focus and ▲ and ● flash when you cannot adjust the focus any farther
- Details are on pages 36-37.





## Viewfinder Displays (Continued)

### Lithium Cell ( )

- This indicator appears for a few seconds when you turn on the camcorder and the clock cell is missing or needs to be replaced.
- *Details are on page 17.*

### Animation, Time-Lapse, and Five-Second Recording Indicators ( 15S and 5S )

-  5S appears when you press the 5SEC. REC button for five-second recording. *Details are on page 33.*
- The interval time selected for time-lapse recording (  15S, 30S, 1MIN, or 5MIN ) appears here. *Details are on pages 50-51.*
- The recording time selected for animation or time-lapse recording (  1/4S, 1/2S, 1S, or 5S ) appears here. *Details are on pages 48-50 and 50-51.*

### Steady Pix™ Indicator ( )

- Press the STEADY PIX button to turn the Steady Pix feature on or off.
- The Steady Pix indicator (  ) appears when the Steady Pix feature is on.
- *Details are on page 41.*

### Tape Length (T30)

The tape length (T20, T30, T35, or T40) selected in the TAPE LENGTH menu appears here.

- *Details are on pages 22-24.*

### Tape Speed Indicators (SP or SLP)

The tape speed selected with the SP/SLP button appears here.

- *Details are on page 22.*

### TBC (Time Base Corrector)

- During playback, press and hold the STEADY PIX button to turn TBC on or off. TBC appears when the time base corrector is turned on. *Details are on page 57.*

### Time Counter (M0:00:00)

- The time counter appears during playback. It is not recorded.
- An “M” appears in front of the time counter when memory-stop is on.
- *Details are on page 57.*

### Time-Remaining Display (5MIN)

The approximate time remaining on the tape is automatically displayed. The correct tape length must be set in the TAPE LENGTH menu.

- *Details are on pages 24-25.*

### Warnings and Information

- **CONDENSATION OPERATION PAUSED PLEASE WAIT** appears when excessive moisture has entered the camcorder. Place the camcorder in a warm, dry area until this indicator disappears.
- **LENS COVER** briefly flashes to remind you to open the lens cover. **LENS COVER** might flash when the camcorder is used in dark areas -- even if the lens cover is open.
- **TAPE END** appears when the end of the tape is reached during recording or a cassette is inserted with its tape already at the end.
- **HEAD CLEANING REQUIRED USE CLEANING CASSETTE** appears when the tape head is dirty.

## Recording

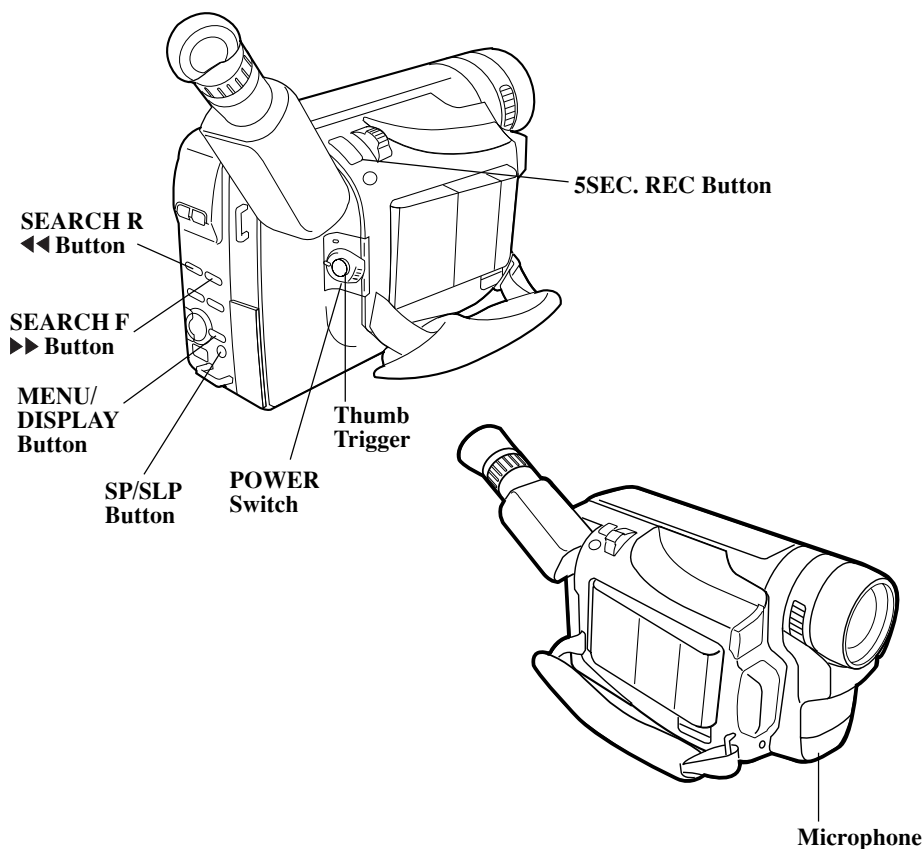

### AutoShot™ Mode

The *POWER* switch lets you select automatic or manual control of several features.

#### To Turn on the AutoShot™ Mode

1. Set the *POWER* switch to *CAMERA AUTO*. The power indicator lights and the camcorder enters record-pause.  $\equiv$ PAUSE $\equiv$  appears in the viewfinder.
2. Press the thumb trigger to start recording.

- The camcorder automatically controls focus, exposure, and white balance.
- The *MENU/DISPLAY* button and menu *PUSH* dial will not operate.
- *AUTO DATE* is selected for the date and time display.

#### To Turn Off the AutoShot™ Mode

1. Set the *POWER* switch to *CAMERA MAN*.

## Five-Second Record Feature

The five-second record feature allows you to record for five seconds providing short scene transitions.

1. Set *POWER* switch to *CAMERA AUTO* or *CAMERA MAN*.
2. Make sure the *SP/SLP* button is set to *SP*. Press *and hold* to change.
3. Press *5SEC. REC* to display  *5S* in the viewfinder.
4. Press the thumb trigger to start recording. The camcorder records for five seconds and enters record-pause.

### To Turn Off the Five-Second Record Mode

1. Press the *5SEC. REC* button to remove  *5S* from the viewfinder.



## Quick Review Feature

Press and release *SEARCH R*  when the camcorder is in record-pause to review the last few seconds of a recording. The *POWER* switch must be set to *CAMERA AUTO* or *CAMERA MAN*.

The camcorder plays back the last few seconds of the recording, returns the tape to its previous position, and returns to record-pause.

## Camera Edit Feature

The camera edit feature allows you to position the tape when the camcorder is in record-pause. Set *POWER* switch to *CAMERA AUTO* or *CAMERA MAN*.

- Press and hold *SEARCH R*  to visually search the recorded tape in reverse.
- Press and hold *SEARCH F*  to visually search forward on the recorded tape.

Release the button to return the camcorder to record-pause at that point on the tape. Press the thumb trigger to start recording at this point.

## Flying Erase Head

A separate erase head is mounted on the spinning headwheel (hence the term “flying”). This allows you to make clean edits without the “glitches” or “rainbow noise” that might occur at the beginning or the end of recordings.

## MENU/DISPLAY Button

Press and *hold* the *MENU/DISPLAY* button for more than one second to remove or display the battery level indicator, tape-length indicator, and tape-remaining display.

# Recording

## Zooming

You can zoom in and out for close ups or wide-angle shots just by moving the zoom lever on the camcorder. The camcorder automatically focuses when you zoom at most distances. Digital zooming allows you to zoom up to 200 times.

To record a close-up of a small subject closer than three feet. Turn on the *TELE MACRO* feature in the menu. You can record a small subject at a distance of approximately 23 inches.

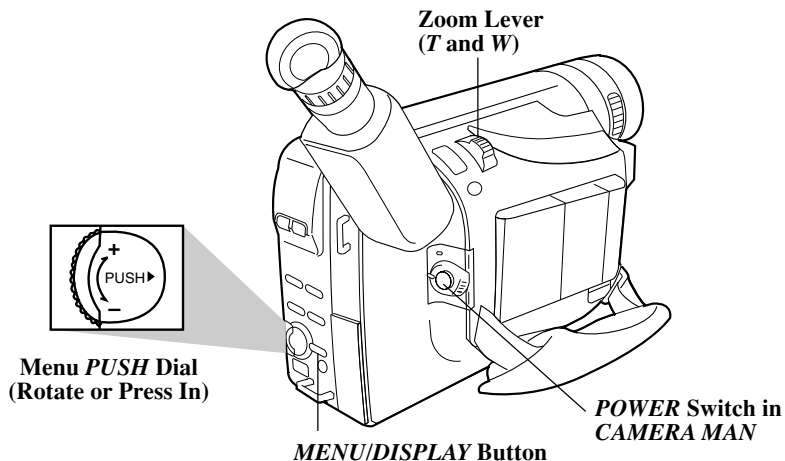

### Use the Zoom Lever (W and T)

1. To zoom in or out (up to 16 times), rotate the zoom lever.
  - To move the lens in the telephoto (close-up) direction, rotate the zoom lever toward *T*.
  - To move the lens in the wide angle direction, rotate the zoom lever toward *W*.
  - The zoom level indicator appears in the viewfinder during zooming.

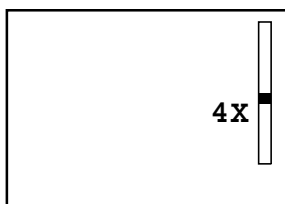

### Digital Zooming

Digital zooming makes zooming possible from 16X (the optical zoom limit) to a maximum of 200X.

1. Set the *POWER* switch to *CAMERA MAN*.
2. Press *MENU/DISPLAY* to display the menu. Rotate the menu *PUSH* dial to highlight *D. ZOOM*.

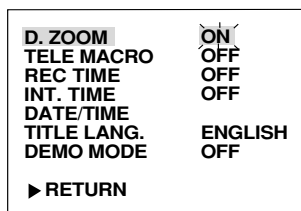

# Recording

## Zooming (Continued)

3. Press the menu *PUSH* dial in to display the *D. ZOOM* menu.

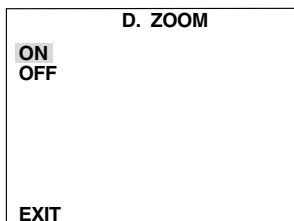

4. Rotate the menu *PUSH* dial to highlight *OFF* or *ON*.

- Select *ON* to turn digital zooming on.
- Select *OFF* to turn digital zooming off.

5. Press the menu *PUSH* dial *twice* to turn digital zooming on or off and remove the menus from the viewfinder.

**Notes:** As the zoom level increases, the picture gradually becomes less sharp. Digital zooming is recommended mainly for special effects.

## Tele Macro Zooming

1. Set the *POWER* switch to *CAMERA MAN*.
2. Press *MENU/DISPLAY* to display the menu. Rotate the menu *PUSH* dial to highlight *TELE MACRO*.

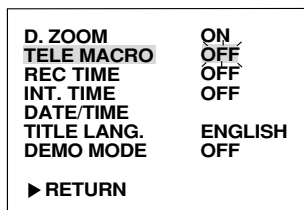

3. Press the menu *PUSH* dial in to display the *TELE MACRO* menu.

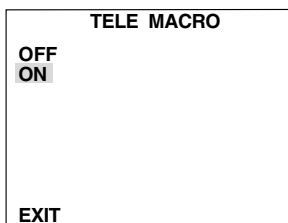

4. Rotate the menu *PUSH* dial to highlight *ON* or *OFF* and press the dial in.
  - Select *ON* if you want to record a small subject within approximately 24 inches.
  - Select *OFF* for normal zooming.
5. Press the menu *PUSH* dial *twice* to turn tele macro zooming on or off and remove the menus.

# Recording

## Focusing

The camcorder adjusts focus automatically under normal conditions. You might need to focus manually under certain conditions.

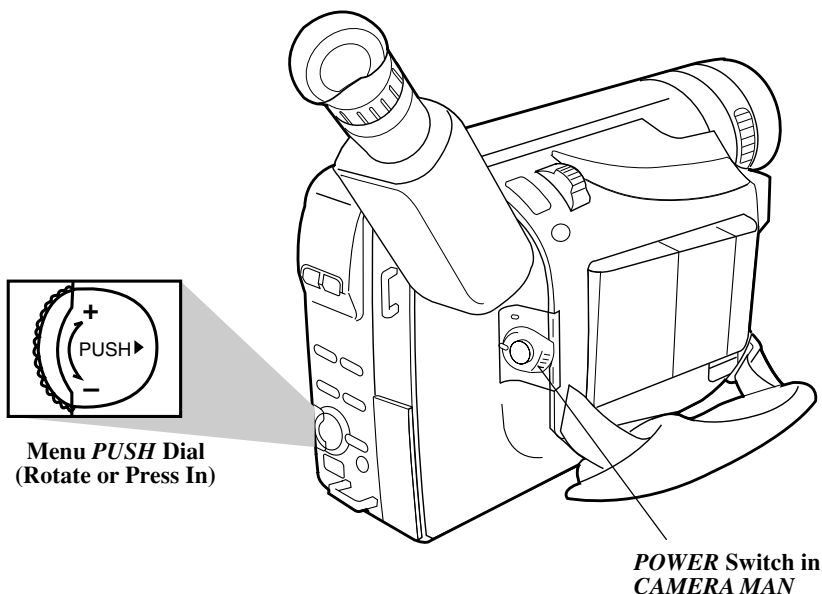

## Auto Focus

During auto focus the camcorder focuses on the object located in the center area of the viewfinder.

- Set the *POWER* switch to *CAMERA AUTO* to turn on the auto focus feature. No focus indicator appears in the viewfinder.

**Notes:** The low-contrast indicator (▲ ▽) in the viewfinder indicates the auto-focus system might not

operate correctly due to low illumination, low or no contrast, repeated patterns, or two subjects at different distances overlapping.

Use tele macro zooming when recording a subject close to the lens or the camcorder may zoom out to focus.

The lens must be clean for the camcorder to focus accurately.

# Recording

## Focusing (Continued)

### Manual Focus



You might need to focus manually under certain conditions.

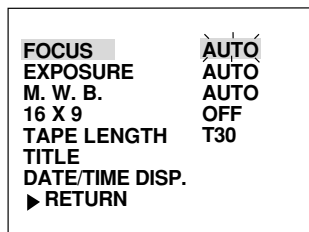

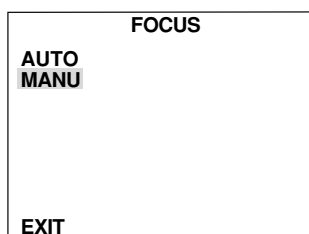

1. Set the *POWER* switch to *CAMERA MAN*.
2. Rotate the zoom lever to *T* to zoom in on the subject and center the subject in the viewfinder.
3. Press the menu *PUSH* dial in to display the menu in the viewfinder. *FOCUS* is highlighted.



4. Press the menu *PUSH* dial in to display the *FOCUS* menu.



5. Rotate the menu *PUSH* dial to highlight *MANU* and press the dial in.   appears in the viewfinder. The focus is locked at this point.

6. Adjust the focus for a subject nearer or farther away.
  - Rotate the menu *PUSH* dial up to focus on a subject farther away.  flashes while you are adjusting the focus and  flashes when you cannot adjust the focus any more.
  - Rotate the menu *PUSH* dial down to focus on a subject nearer.  flashes while you are adjusting the focus and  flashes when you cannot adjust the focus any more.
7. Press the menu *PUSH* dial *twice* to remove the menus.

**Note:** To return to auto focus, select *AUTO* in the *FOCUS* menu or set the *POWER* switch to *CAMERA AUTO*.

### Conditions Requiring Manual Focus

- When recording a subject through a window.
- When recording a subject having a close foreground and a background that is far away.
- When recording in low-light situations.
- When recording two subjects at different distances that overlap in the same scene.
- When the subject is not in the center of the scene.
- When recording a scene with fast motions, like a tennis swing.

# Recording

## White Balance

Making colors look natural is what white balance is all about. This is achieved by adjusting the way the camcorder “sees” and records the light source in the scene you record. Your camcorder is equipped with automatic white balance.

You might want to adjust white balance manually under certain conditions, such as recording an object with various shades of the same color or when recording a predominantly red or brown object outdoors.

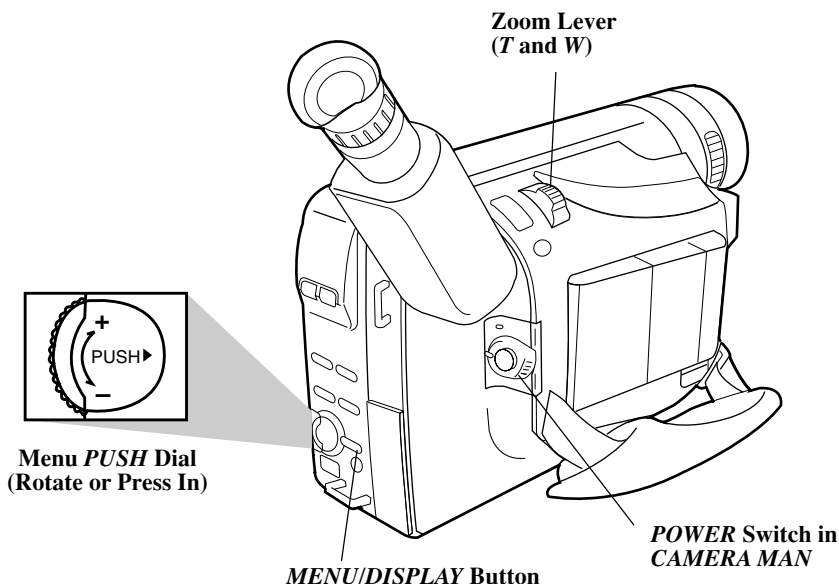

### Auto White Balance

During auto white balance, the camcorder adjusts the white balance.

- Set the *POWER* switch to *CAMERA AUTO* to turn on the automatic white balance feature. No indicator appears in the viewfinder.

### Manual White Balance

1. Set the *POWER* switch to *CAMERA MAN*.
2. Press the menu *PUSH* dial in to display the menu in the viewfinder. *FOCUS* is highlighted.



## White Balance (Continued)

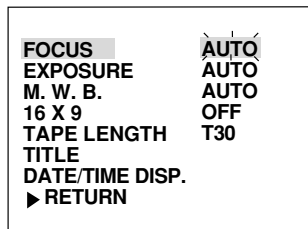

3. Rotate the menu *PUSH* dial to highlight *M.W.B.* and press the dial in to display the *M.W.B.* menu.

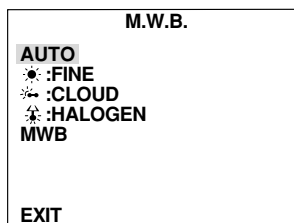

4. Rotate the menu *PUSH* dial to highlight the white balance you want to use.
  - No indicator appears when you select *AUTO* white balance.
  - Select ☀:FINE when recording outdoors on a sunny day.
  - Select ☁:CLOUD when recording outdoors on a cloudy day.
  - Select 🔦:HALOGEN when recording using halogen or tungsten lighting.
  - Select *MWB* when shooting subjects with different color temperatures and adjust the white balance as follows:

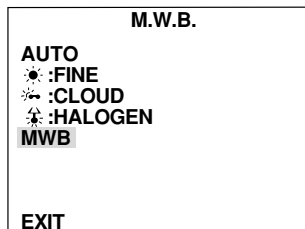

**Note:** Connecting your camcorder to a color TV monitor may be helpful when making white balance adjustments.

A. Point camcorder at a white, flat object such as a piece of white paper.

B. While *MWB* is highlighted, press and hold the menu *PUSH* dial until *MWB* starts flashing.

The *MWB* indicator flashes while the camcorder is adjusting white balance and stops flashing when it is ready to record.

**Note:** To change the tint for special recording, substitute colored paper for white. The white balance is adjusted based on the color.

Red paper – deeper green  
Blue paper – orange  
Yellow paper – deeper purple

5. Press the menu *PUSH* dial in to remove the menus.

**Notes:** To return to auto white balance, select *AUTO* in the *M.W.B.* menu or set the *POWER* switch to *CAMERA AUTO*.

# Recording

## Exposure Control

The camcorder controls the iris for you when the *POWER* switch is set to *CAMERA AUTO*. The camcorder adjusts brightness automatically under normal conditions. You might need to adjust brightness manually when the background is too bright or too dark in comparison with the subject.

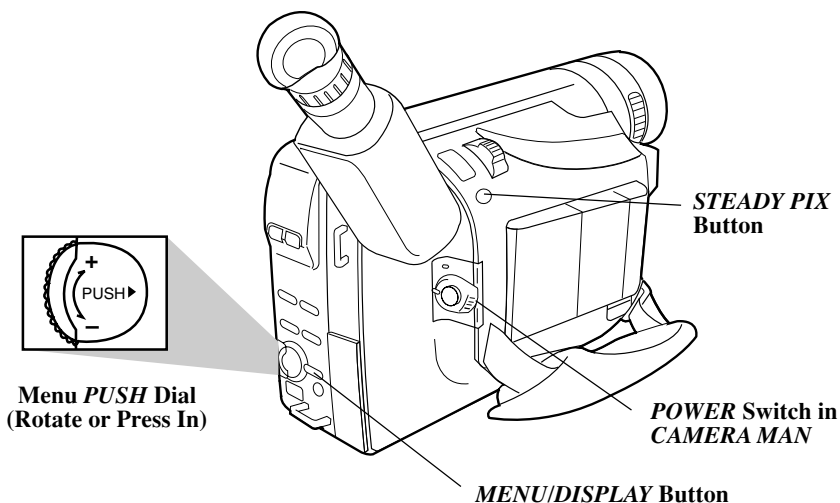

## Auto Exposure

The camcorder adjusts the iris for the best possible picture during auto exposure.

- Set the *POWER* switch to *CAMERA AUTO* to turn on the automatic exposure feature. No indicator appears in the viewfinder.

## Manual Exposure

You may need to adjust exposure manually under certain conditions, such as those listed *on the next page*.

1. Set the *POWER* switch to *CAMERA MAN*.

2. Press the menu *PUSH* dial in to display the menu in the viewfinder. *FOCUS* is highlighted.

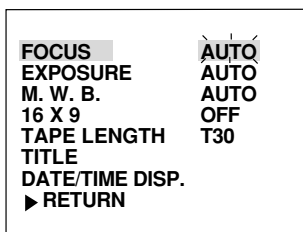

3. Rotate the menu *PUSH* dial to highlight *EXPOSURE*, and press the dial in to display the *EXPOSURE* menu.

## Exposure Control (Continued)

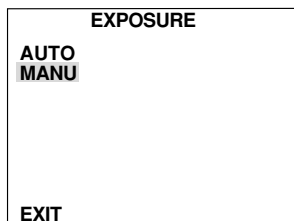

4. Rotate the menu *PUSH* dial to highlight *MANU* (manual) and press the dial in. The exposure indicator (00) appears in the viewfinder.
5. Adjust the exposure for a dark or bright subject. The exposure you select appears in the viewfinder.
  - To brighten the image, rotate the menu *PUSH* dial up. You can adjust the exposure to +06.
  - To darken the image, rotate the menu *PUSH* dial down. You can adjust the exposure to -06.
6. Press the menu *PUSH* dial in twice to select an exposure and remove the menus from the viewfinder.

**Note:** To return to auto exposure, select *AUTO* in the *EXPOSURE* menu or set the *POWER* switch to *CAMERA AUTO*.

### Conditions Requiring Manual Exposure

- When recording with a bright background or reverse lighting.
- When recording with a very dark background or very bright subject.
- When recording a reflective natural background — such as a beach or when skiing.

## Steady Pix™ Feature

The Steady Pix feature corrects slight shaking of images during some recording modes.

- While zooming in on a distant subject.
- When recording an approaching small subject.
- When recording while walking or riding in a vehicle.
- When recording through a vehicle's window.

### To Use the Steady Pix™ Feature

- Press the *STEADY PIX* button to turn the Steady Pix feature on. The Steady Pix indicator (📷) appears in the viewfinder.
- Press the *STEADY PIX* button to turn the Steady Pix feature off. The Steady Pix indicator (📷) disappears.

**Notes:** Turn the Steady Pix feature off when using a tripod.

There is a small change in the picture size when using the Steady Pix feature.

Accurate stabilization may not be possible if hand shake is excessive or when shooting the following:

- Subjects with vertical or horizontal stripes.
- Dark or dim subjects.
- Subjects with excessive backlighting.
- Scenes with movement in various directions.
- Scenes with low-contrast backgrounds.

## Fade or Wipe In or Out

You can add a professional touch to your recordings when you fade or wipe in and out of scenes. The picture gradually appears or disappears. The speed of the fade or wipe is controlled by the camcorder.

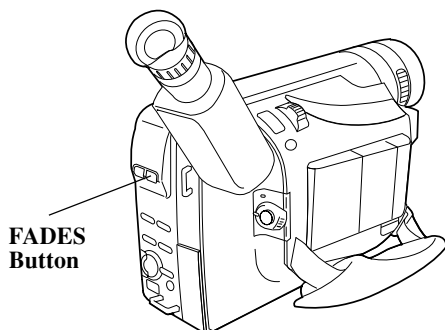

### To Fade or Wipe In or Out

1. Set the *POWER* switch to *CAMERA MAN*.
2. Repeatedly press the *FADES* button. The indicator for the fade or wipe you select will appear.

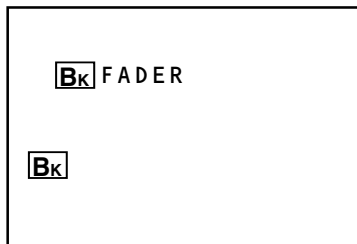

- Select **BK** *FADER* to fade in and out to/from a black screen.
- Select **MOSAIC** *MOSAIC* to fade in and out to/from a mosaic effect.

- Select **SCROLL** *SCROLL* wipe to have the scene wipe in with a black screen from the bottom to the top or wipe out from the top to the bottom.
- Select **SLIDE** *SLIDE* wipe in with a new image from right to left or wipe out with a black screen moving from left to right.
- Select **DOOR** *DOOR* wipe to have the scene wipe in with a black screen moving from the center out to the sides or wipe out moving from the sides into the center.
- Select **CW:CORNER** to wipe in from the upper right corner to lower left corner or wipe out from the lower left corner to the upper right corner.
- Select **WW:WINDOW** to have the next scene wipe in from the center to the corners covering the previous scene.
- Select **OFF** if you do not want to fade or wipe in or out.

3. Press the thumb trigger to start or stop recording. The camcorder fades in or out of the scene.

**Notes:** The screen becomes slightly reddish if fade is used with the sepia feature.

If the haze feature is selected, **BK** *FADER* fades in and out from a white screen.

## Fade or Wipe In or Out (Continued)

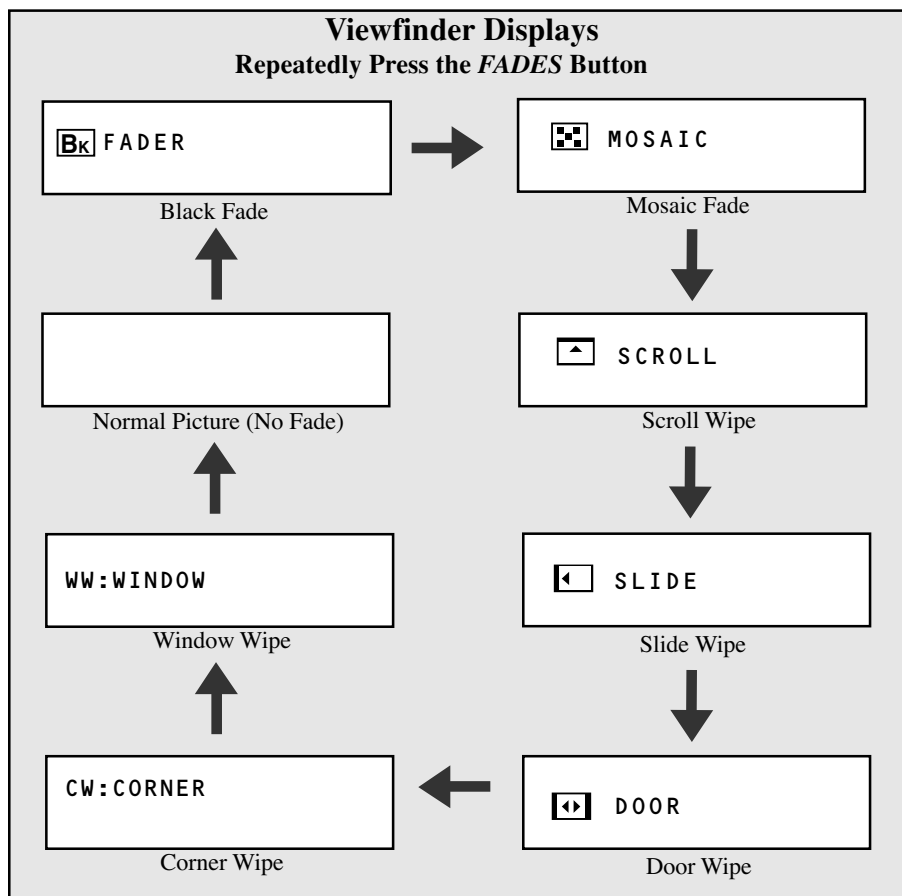

### Fade or Wipe In

1. Press the thumb trigger to pause recording.
2. Repeatedly press *FADES* to select the fade or wipe you want to use.

**Note:** The last fade or wipe used appears the first time you press *FADES*.

3. Press the thumb trigger to start recording. The picture and sound gradually appear in place of the blank screen.

### Fade or Wipe Out

1. During recording, repeatedly press *FADES* to select a fade or wipe.  
**Note:** The last fade or wipe used appears the first time you press *FADES*.
2. Press *FADES* to stop recording. The picture and sound gradually disappear.





# Recording

## **P. (Program) AE Button**

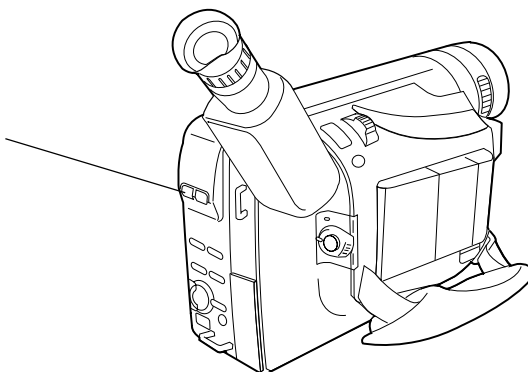
The *P.* (Program) *AE* button lets you select one of several different effects. Press the button to select the effect you want. The name and indicator for the effect appears briefly and then the indicator remains.

***P.* (Program)  
*AE* Button**



| Indicator and Name  | Uses  |
|---|---|
|  <i>SEPIA</i>        | Picture is recorded in sepia (brownish red) and offers the vintage look of old movies.  |
|  <i>SPORTS</i>       | Use to capture fast-moving action with less blurring. Use when playing back a recording on a VCR featuring special effects, such as pause or slow motion.   |
| <i>SD:SHADOW</i>  | Use to counter effects of glare and darken the picture with a black mist.   |
| <i>HZ:HAZE</i>  | Use to soften the image and give the picture a misty white effect.  |
|  <i>TWILIGHT</i>   | Use for twilight scenery, fireworks, etc. to make them look more natural and dramatic.  |
|  <i>2 S 1/2000</i> | Sets shutter speed to 1/2000. Use to record faster moving action than sports mode with less blurring. Use when playing back a recording on a VCR featuring special effects, such as pause or slow motion. |
|  <i>NEGA POSI</i>  | Use to reverse the color (create a negative image).   |
| <i>OFF</i>  | Use to turn off all special effects.  |

# Recording

## 16X9 Mode

The camcorder has a wide recording mode that lets you make recordings compatible with the 16X9 format. When 16X9 is activated, the camcorder records black bars at the top and bottom of the picture to produce the wide-screen effect. This is also known as “letterbox” recording.

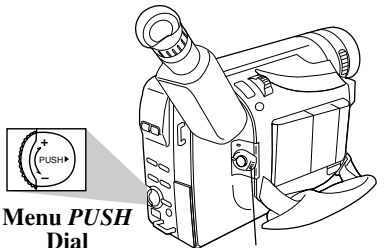

**Menu PUSH Dial**  
(Rotate or Press In)

**POWER Switch in CAMERA MAN**

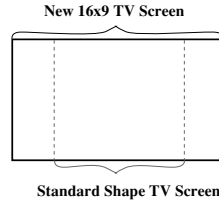

**Caution:** Do not use this mode unless you have a compatible 16 X 9 TV. When played on a regular TV, black bars appear in the picture.

1. Set the **POWER** switch to **CAMERA MAN**.
2. Press the menu **PUSH** dial in to display the menu in the viewfinder. **FOCUS** is highlighted.

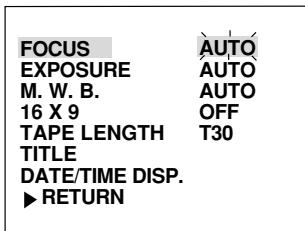

3. Rotate the menu **PUSH** dial down to highlight **16X9** and press it in to display the **16X9** menu.

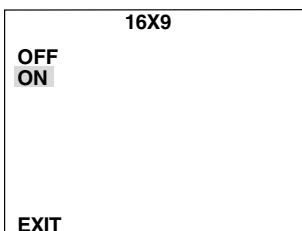

4. Rotate the menu **PUSH** dial to highlight **OFF** or **ON**.
  - Select **ON** to record 16X9.



- Select **OFF** to turn off 16X9.



5. Press the menu **PUSH** dial *twice* to turn 16X9 on or off and remove the menus from the viewfinder.

# Recording

## Preset Titles

The title feature lets you choose one of eight preset titles. You can also choose the language for your titles.

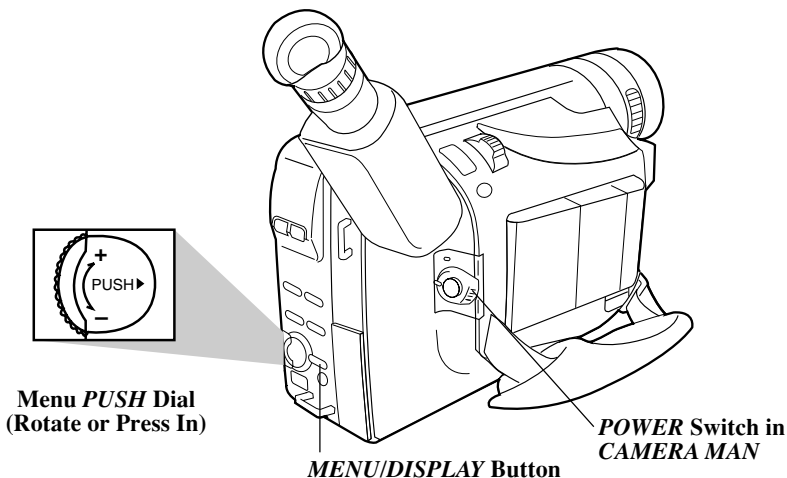

## Select a Language for the Title

You can select English, French, or Spanish to record your preset titles.

1. Set the *POWER* switch to *CAMERA MAN*.
2. Press the *MENU/DISPLAY* button to display the menu in the viewfinder. *D. ZOOM* is highlighted.

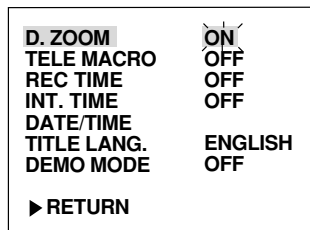

3. Rotate the menu *PUSH* dial down to highlight *TITLE LANG.* and press the

menu *PUSH* dial in to display the *TITLE LANG.* menu.

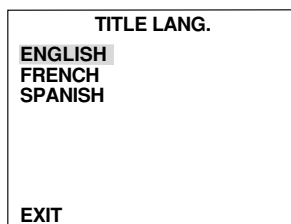

4. Rotate the menu *PUSH* dial to highlight the language you want to use to record the preset title.
5. Press the menu *PUSH* dial twice to select the language and remove the menus.



# Recording

## Preset Titles (Continued)

### Record a Preset Title

1. Set the *POWER* switch to *CAMERA MAN*.
2. Press the menu *PUSH* dial in to display the menu in the viewfinder. *FOCUS* is highlighted.

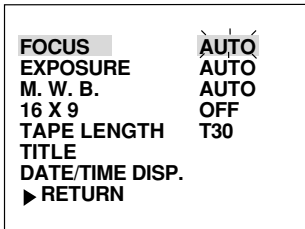

3. Rotate the menu *PUSH* dial down to highlight *TITLE*.

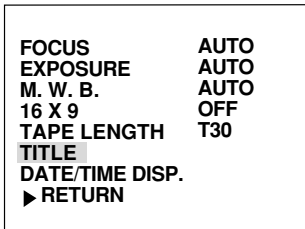

4. Press the menu *PUSH* dial in to display the *TITLE* menu.

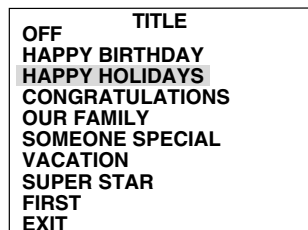

5. Rotate the menu *PUSH* dial down to highlight the title you want to record, and press the dial twice to select the title and remove the menus.
6. Start recording. The title you selected is superimposed and recorded on your tape.

### To Stop Recording the Title

1. Set the *POWER* switch to *CAMERA MAN*.
2. Press the menu *PUSH* dial in to display the menu in the viewfinder. *FOCUS* is highlighted.
3. Rotate the menu *PUSH* dial down to highlight *TITLE* and press the dial in to display the *TITLE* menu.
4. Rotate the menu *PUSH* dial down to highlight *OFF* and press the dial in *twice* to turn off the title and remove the menus.

# Recording

## Animation Recording

You can produce an illusion of movement for an otherwise stationary scene or object by shooting a series of pictures of slightly different poses (such as cartooning).

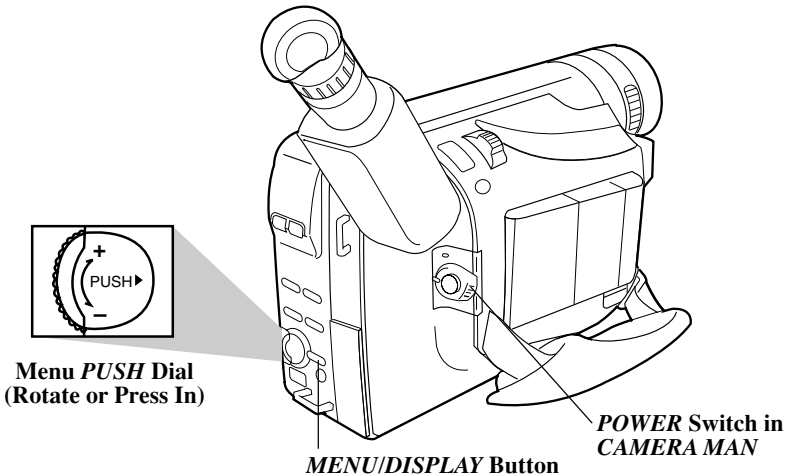

## To Record Using Animation

1. Set the *POWER* switch to *CAMERA MAN*.
2. Press *and hold* *SP/SLP* to select *SP*. *SP* appears in the viewfinder.
3. Press the *MENU/DISPLAY* button to display the menu in the viewfinder. *D. ZOOM* is highlighted.

|             |         |
|-------------|---------|
| D. ZOOM     | ON      |
| TELE MACRO  | OFF     |
| REC TIME    | OFF     |
| INT. TIME   | OFF     |
| DATE/TIME   |         |
| TITLE LANG. | ENGLISH |
| DEMO MODE   | OFF     |
| ▶ RETURN    |         |

# Recording

## Animation Recording (Continued)

4. Rotate the menu *PUSH* dial down to highlight *REC TIME* and press the dial in to display the *REC TIME* menu.

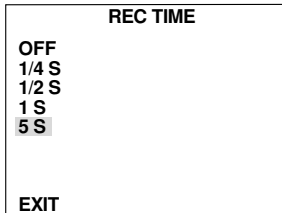

5. Rotate the menu *PUSH* dial to highlight the amount of time you want the camcorder to record.

- Select *1/4S* to record for 1/4 second.
- Select *1/2S* to record for 1/2 second.
- Select *1S* to record for one second.
- Select *5S* to record for five seconds.
- Select *OFF* if you do not want to record for a selected amount of time.

6. Press the menu *PUSH* dial *twice* to exit the menu.

7.  and the amount of recording time appear in the viewfinder.

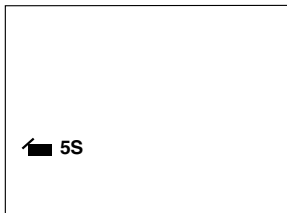

8. Press the thumb trigger to start recording.

**Note:** The recording stops automatically after the selected period of recording time. You might want to take two to five shots of the subject in the same position.

9. Move the subject and repeat step 8 for the desired number of shots.

**Note:** Fade does not operate during animation or time-lapse recording.

## To Stop Animation Recording

Set the *REC TIME* in the menu to *OFF*.

# Recording

## Time-Lapse Recording

You can make automatic recordings at preset time intervals. The recording shows subtle changes (such as shifts in cloud formations or plant growth) when it remains focused on an object.

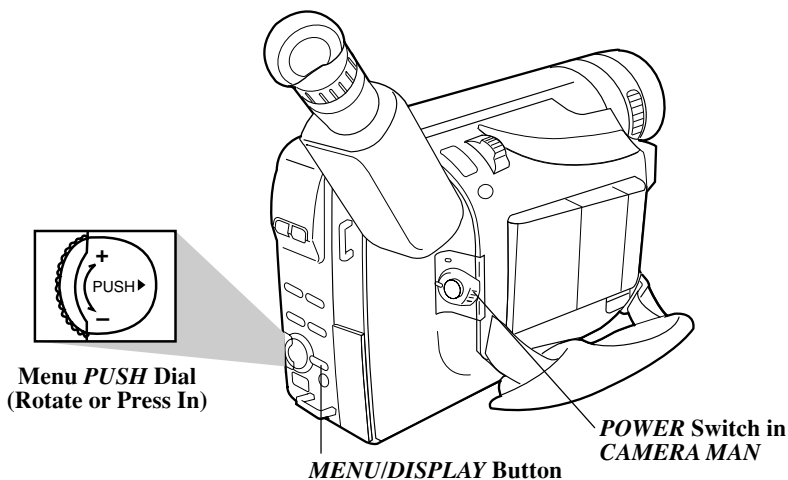

### To Record Using Time Lapse

1. Set the *POWER* switch to *CAMERA MAN*.
2. Press and hold *SP/SLP* to select *SP*. *SP* appears in the viewfinder.
3. Press the *MENU/DISPLAY* button to display the menu in the viewfinder. *D. ZOOM* is highlighted.
4. Rotate the menu *PUSH* dial to highlight *REC TIME* and press it in to display the *REC TIME* menu.

|             |         |
|-------------|---------|
| D. ZOOM     | ON      |
| TELE MACRO  | OFF     |
| REC TIME    | OFF     |
| INT. TIME   | OFF     |
| DATE/TIME   |         |
| TITLE LANG. | ENGLISH |
| DEMO MODE   | OFF     |
| ▶ RETURN    |         |

| REC TIME |
|----------|
| OFF      |
| 1/4 S    |
| 1/2 S    |
| 1 S      |
| 5 S      |
| EXIT     |

## Time-Lapse Recording (Continued)

5. Rotate the menu *PUSH* dial to highlight the amount of time you want the camcorder to record.
  - Select *1/4S* to record for 1/4 second.
  - Select *1/2S* to record for 1/2 second.
  - Select *1S* to record for one second.
  - Select *5S* to record for five seconds.
6. Press the menu *PUSH* dial in to select a recording time and return to the menu.
7. Rotate the menu *PUSH* dial to highlight *INT. TIME* and press it in to display the *INT. TIME* menu.

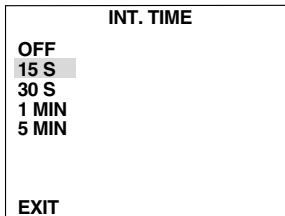

**Note:** You cannot select an *INT. TIME* if no *REC TIME* is selected.



8. Rotate the menu *PUSH* dial down to highlight the desired time between recordings (*15S*, *30S*, *1 MIN*, or *5 MIN*).
  - Select *15S* to delay the recording for 15 seconds.
  - Select *30S* to delay the recording for 30 seconds.

- Select *1 MIN* to delay the recording for one minute.
- Select *5 MIN* to delay the recording for five minutes.
- Select *OFF* if you do not want the camcorder to delay recording.

9. Press the menu *PUSH* dial *twice* to select a time and exit the menus.

 and the amount of recording time and  and the amount of interval time between recordings appear in the viewfinder

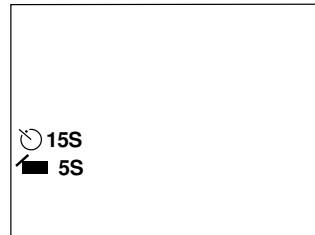

10. Press the thumb trigger to start recording.

**Note:** The camcorder starts and stops recording the selected amount of time.

**Note:** Fade does not operate during animation or time-lapse recording.

## To Stop Time-Lapse Recording

Set the *REC TIME* and *INT. TIME* in the menus to *OFF*.

# Recording

## Demo Mode

You can turn on the *DEMO* mode in the *MENU* to have a demonstration of some of the camcorder's features.

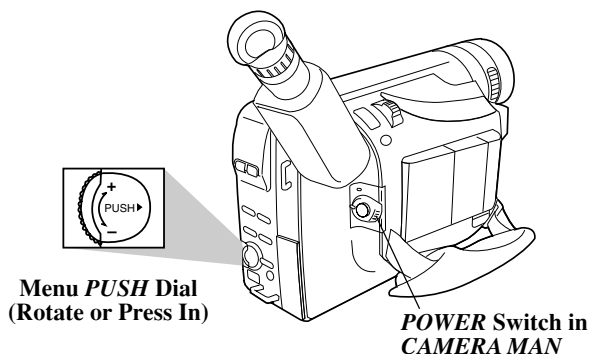

### To Turn the Demo Mode On

1. Set the *POWER* switch to *CAMERA MAN*.
2. If a cassette is inserted, remove the safety tab or set it to *REC OFF*.
3. Press the *MENU/DISPLAY* button to display the menu in the viewfinder. *D. ZOOM* is highlighted.

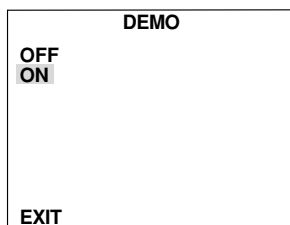
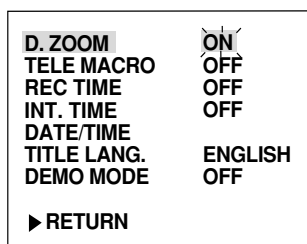

5. Rotate the menu dial to highlight *OFF* or *ON*. Press the menu *PUSH* dial twice to select *ON* or *OFF* and remove the menus.
  - Select *ON* if you want the camcorder to demonstrate some of the recording features.

**Note:** Zoom is the only feature that operates during the demo mode.

  - Select *OFF* if you do not want a demonstration.
4. Rotate the menu *PUSH* dial down to highlight *DEMO MODE* and press it in to display the *DEMO* menu.

### To Turn the Demo Mode Off

Turn off the camcorder.

## Attach the Shoulder Strap

The camcorder's shoulder strap is designed to let you carry the camcorder from your shoulder and – when you are ready to shoot – bring the camcorder to shooting position in one quick movement.

### To Attach the Shoulder Strap

1. If the strap keeper is over a double section of the strap, slide the strap keeper off the end of the strap. Replace the keeper on the strap between the buckle and the end of the strap *as shown*.
2. Loop the end of the strap over the top of the shoulder strap attachment ring.

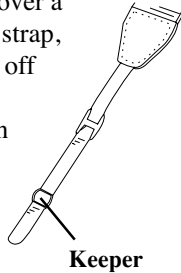

3. Thread the end of the strap back through the keeper and buckle making sure it is threaded under the outer strap. Make sure the strap is not twisted.

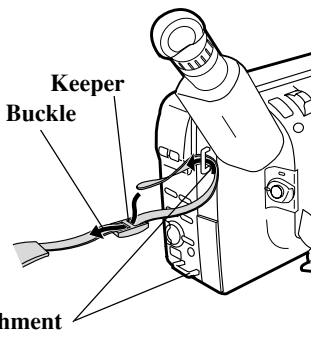
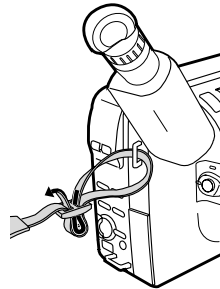

4. Attach the other end of the strap to the other shoulder strap attachment ring.
5. Adjust the shoulder strap to the desired length.
6. Slide both keepers up snugly against the shoulder strap attachment rings to prevent the strap from slipping.

**Cautions:** When carrying the camcorder with the shoulder strap, you may find it convenient to rotate the viewfinder down. This helps prevent possible damage to the viewfinder from bumping against your body as you move. Make sure the shoulder strap is firmly attached before using it to carry the camcorder.

## Traveling Tips

- Write down your camcorder's serial number and keep it separate from the camcorder when traveling. If your camcorder is lost or stolen, you will be able to identify it.
- Use extra care to avoid damage to your camcorder and accessories when operating them at a beach or pool. Spray, sand, and dust should be avoided. If your lens has been exposed to the elements, clean it only with proper lens cleaning supplies.
- Make sure you have any plug adapters that you might need before taking your camcorder to other countries. Consult your dealer for advice.
- Carry your camcorder in a carrying case when traveling. *See page 62* for a case designed especially for this camcorder. An ordinary suitcase or carry bag does not offer the protection your camcorder needs. Treat your camcorder as carry-on luggage to protect it from rough handling.



# Playback

## Use the Viewfinder for Playback

You can see tapes using the viewfinder. There is no sound during viewfinder playback.

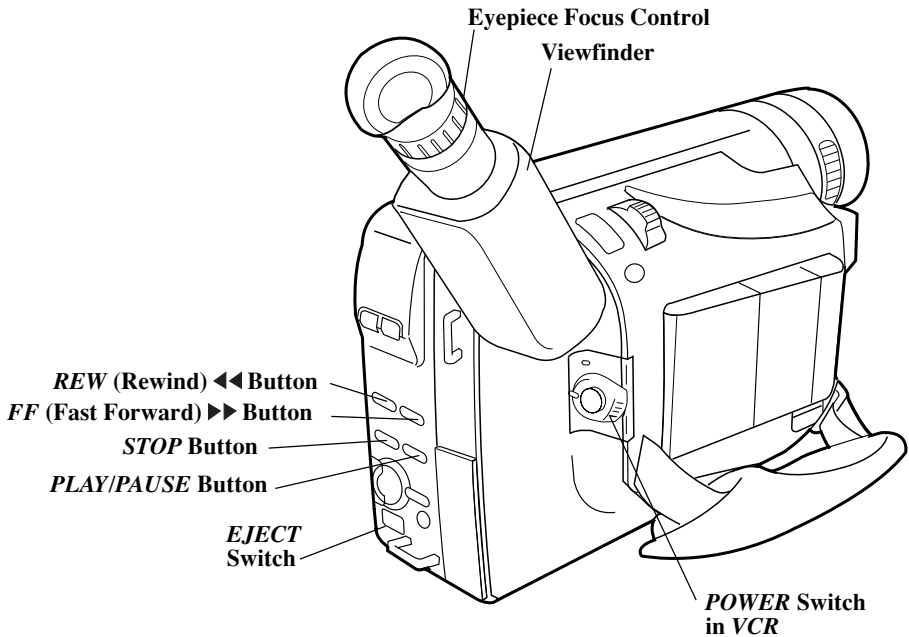

## To Play Back a Tape

### 1. Attach a power supply.

Attach the adapter/charger, charged battery, or optional car cord.

### 2. Insert a tape.

- Slide the *EJECT* switch to open the cassette compartment.
- Turn the tape wheel on the cassette to remove any slack from the tape.
- Insert the cassette with the tape wheel facing up and the tape window facing out.
- Press on the *PUSH* button to lock the cassette compartment closed.

### 3. Set the *POWER* switch to *VCR*.

The power indicator lights.

### 4. Adjust the viewfinder for a comfortable viewing position.

- Turn the eyepiece focus control to adjust the focus of the viewfinder for your vision.

### 5. Press the *PLAY/PAUSE* button to begin playback.

- If necessary, adjust tracking.
- During playback, use the playback features *on the following pages*.

### 6. Press the *STOP* button when you are finished.

# Playback

## Playback Features

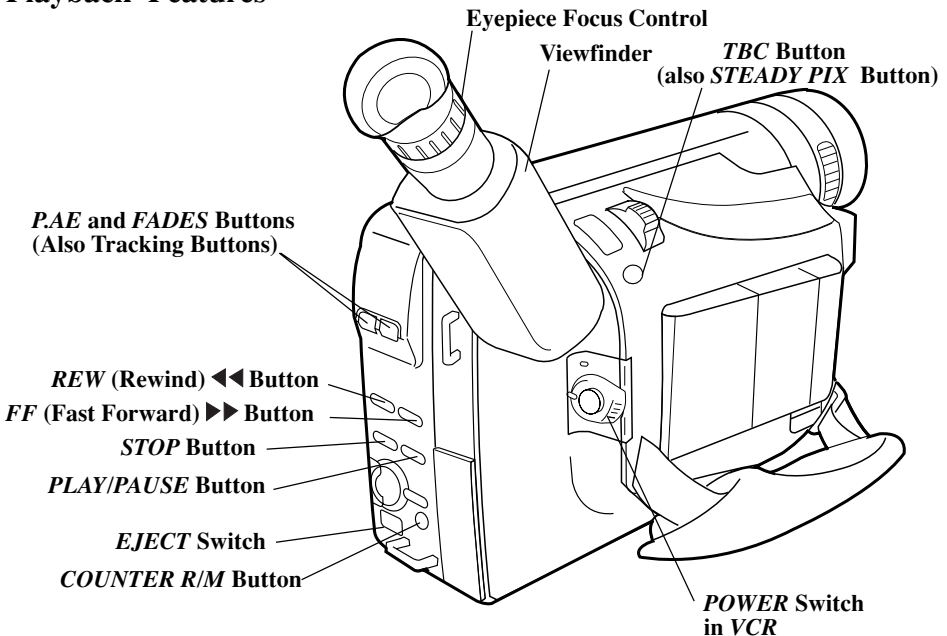

### Position the Tape

Set *POWER* switch to *VCR* and press *STOP*.

- Press and quickly release the *REW* (rewind) ◀◀ button or *FF* (fast forward) ▶▶ button to rewind or fast-forward the tape.
- Press *STOP* to stop the tape.

### Visual Search

- During playback, press and release *REW* (rewind) ◀◀ button or *FF* (fast forward) ▶▶ button if you want to search the tape visually in forward or reverse.
- Press *PLAY/PAUSE* to return to normal playback.
- For brief searching, press and hold *REW* (rewind) ◀◀ button or *FF* (fast

forward) ▶▶ button for more than two seconds. Release the button to return to normal playback.

### Stop-Action Pause

- During playback, press *PLAY/PAUSE* to “stop the action” and view one frame of the tape.
- Press *PLAY/PAUSE* to return to normal playback.

**Caution:** Pause is designed for momentary interruptions and should not be used for an extended period of time. If the camcorder remains in pause for more than five minutes, it enters the stop mode and turns off to prevent excessive tape wear.

## Playback Features (Continued)

### Time Counter

The time-counter display shows the actual time elapsed when playing back a segment of tape. The memory-stop feature helps locate a certain point on the tape. Turn memory stop on to stop the tape automatically during rewind or fast forward when the time counter reaches *M 0:00:00*.

### To Use the Memory-Stop Feature

1. Locate the place on the tape you want to return to, set the *POWER* switch to *VCR*, and press *COUNTER R/M* for more than two seconds to reset the counter to *0:00:00*.
2. Press *COUNTER R/M* for less than one second to turn the time counter's memory-stop feature on or off. When memory stop is on, an *M* appears before the time counter.

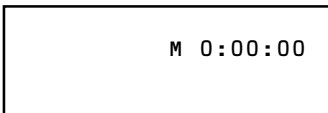

3. Continue to play the tape. When you want to return to the place you marked, press the *STOP* button.
4. Press *REW* ◀◀. The tape rewinds to the time counter reading of *M 0:00:00*.

### Tracking

During playback, streaks may appear in the playback picture. Press both tracking buttons (*PAE* and *FADES* buttons) to

activate manual tracking. Press either button again until the streaks disappear. *MT* appears during manual tracking.



Press both tracking buttons again to turn automatic tracking back on. *AT* flashes in the viewfinder for a few seconds and then disappears.

**Note:** The tracking buttons may have no effect on tapes recorded on other camcorders or VCRs.

### TBC (Time Base Corrector)

During playback, TBC reduces jitter from fluctuating video signals even on old tapes. If picture appears distorted, try turning TBC off.

Press and hold the *STEADY PIX* button for at least one second to turn TBC off or on. It may take a few seconds before TBC actually starts working.

The TBC indicator appears in the viewfinder when TBC is turned on and disappears when TBC is turned off.

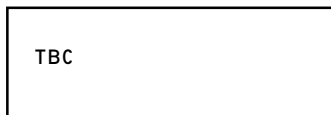

**Notes:** TBC does not operate during visual search or stop-action pause. The picture may be distorted when normal playback resumes after visual search or stop-action pause.

The picture may be distorted if TBC is turned on or off at the edit in/out points.

## Use the Cassette Adapter

The camcorder uses a smaller size cassette, but records in standard VHS format. The cassette adapter allows you to play your VHS-C cassettes in a VCR just like other standard VHS cassettes.

Insert the VHS-C cassette into the cassette adapter. Insert the cassette adapter into the VHS VCR like a normal VHS cassette.

## Install Cassette Adapter's Battery

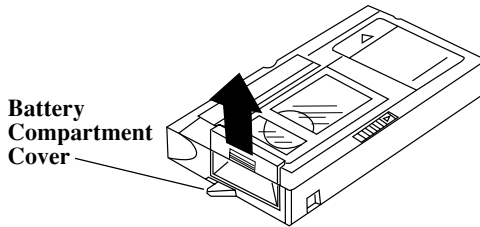

1. Remove battery compartment cover.
2. Install supplied "AA" battery so positive (+) and negative (-) ends align properly with (+) and (-) terminals in battery compartment.
3. Replace battery compartment cover.

**Notes:** Replace the battery when the load time becomes much longer than normal.

Remove the battery from the cassette adapter if it is not used for a month or more. This prevents possible damage from battery leakage. If leakage occurs, wipe up the liquid inside the compartment and replace the battery with a new one.

## Insert Cassette into Cassette Adapter

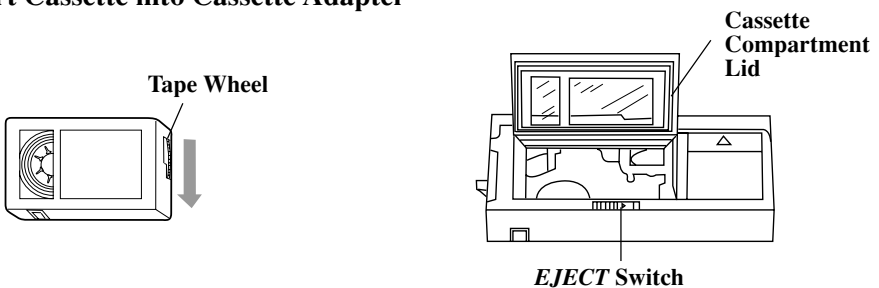

1. Before inserting the cassette into the adapter, remove any slack in the tape by turning the tape wheel on the side of the cassette.
2. Slide *EJECT* to the right to open the cassette compartment lid.
3. Insert the cassette with the tape window on the left and facing up. Allow the cassette to drop into the adapter. **Do not force the cassette.**

## Use the Cassette Adapter (Continued)

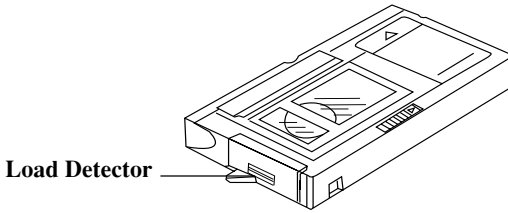

4. Gently close the cassette compartment lid until it locks into place. Make sure the cassette reel area under the adapter is free to turn while the cassette is loading.

**Note:** You should hear a whirring sound while the tape loads. The adapter's load detector will automatically retract into the adapter.

**Caution:** If the load detector is still extending from the side of the cassette adapter after you have attempted to load the cassette, loading is not complete. Try to load the cassette again. Attempting to insert the cassette adapter into a VCR with the load detector extending may cause damage to the adapter and/or VCR.

## Remove Cassette from Cassette Adapter

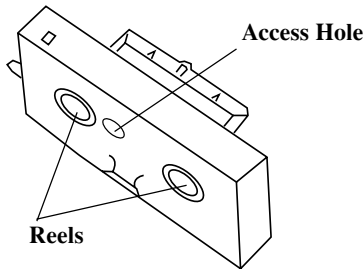

1. Slide the adapter's *EJECT* switch to the right. The load detector extends from the side and the whirring sound indicates the tape is being released before the adapter's cassette compartment lid opens.
2. Use the access hole on the bottom of the adapter to push the cassette up and remove it from the adapter.
3. Gently close the adapter's cassette compartment lid.

**Caution:** Do not touch the reels during loading and unloading. It could cause injury or damage the cassette adapter or tape.

## Playback on TV (or VCR) with Audio/Video Inputs

To connect your camcorder to a TV monitor (or VCR) with audio/video inputs, you need an optional audio/video cable, such as VH83 *shown on page 63*. If your TV is already connected to a VCR, attach the camcorder to the VCR and watch what the camcorder is recording or playing on the TV.

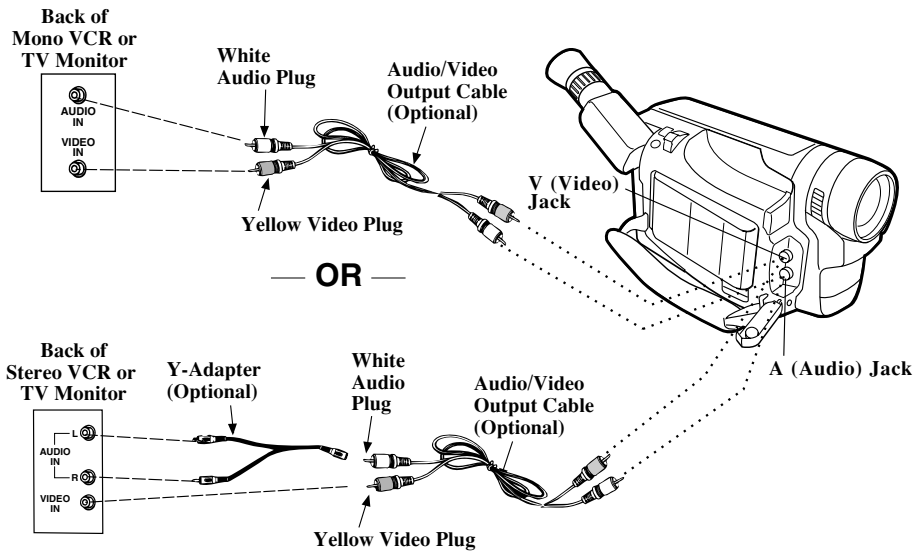

## Installation

1. Attach the white plug on one end of the audio/video cable to the *AUDIO IN* jack on the TV (or VCR).
2. Attach the yellow plug to the *VIDEO IN* jack on the TV (or VCR).
3. Attach the white plug on the other end of the audio/video cable to the *A* (audio) jack (located under the small cover) on the side of the camcorder.
4. Attach the yellow plug to the yellow *V* (video) jack on the camcorder.

**Notes:** If your cable does not have white and yellow plugs, attach the same color to the audio jacks.

If your TV (or VCR) has stereo *AUDIO IN* jacks, attach the plug to the one labeled *MONO*. If one is not labeled *MONO*, you need a Y-adaptor, such as AH25, *shown on page 63* to hear both channels.

## Playback on TV (or VCR) with Audio/Video Inputs *(Continued)*

### Playback Operation and How to Copy Tapes on the VCR

1. A. Camcorder connected directly to TV: Turn on the TV and tune it to the video input channel.
  - During playback, use the playback features *on pages 56-57*.
- B. Camcorder connected to VCR that is already connected to TV: Turn on VCR and place it in the “line” or “camera mode”. (If your VCR does not have a “line” or “camera mode”, consult the VCR owner’s manual.) Operate the TV as you normally do to see the signal coming from the VCR.
2. Set the *POWER* switch to *VCR* to turn on the camcorder. The power indicator lights.
3. Press *PLAY/PAUSE*.
4. To copy what the camcorder is playing, place a blank cassette in the VCR, and press the VCR’s *RECORD* button.

**Note:** Make sure the memory-stop feature is turned off (press *COUNTER R/M*) or the camcorder enters play-pause when the counter reaches *M 0:00:00*.
5. Press *STOP* when you are finished.

**Caution:** The unauthorized recording of copyrighted material may infringe the rights of others.

### Viewing What the Camcorder is Seeing (or Recording)

1. A. Camcorder connected directly to TV: Turn on the TV, and tune it to the video input channel.
  - **Note:** Turn the TV’s volume down to prevent a high-pitched squeal caused by feedback.
- B. Camcorder connected to VCR that is already connected to TV: Turn on VCR and place it in the “line” or “camera mode”. (If your VCR does not have a “line” or “camera mode”, consult the VCR owner’s manual.) Operate the TV as you normally do to see the signal coming from the VCR.
2. Set the *POWER* switch to *CAMERA*.
3. Press the thumb trigger to begin recording. You can watch what the camcorder is seeing (or recording) on the TV screen.

## Optional Accessories

We invite you to take a look at some great ideas for sparking creativity and adding to the fun of using your compact VHS camcorder. The following pages have a selection of accessories to help make your memorable moments look and sound even better.

These accessories are designed to make the process of recording and watching your videos more enjoyable.

**To order accessories, contact your local Dealer.**

If a dealer is not nearby, all accessories are available through toll-free ordering or by using the order form *on page 65*.

### AC201A Soft Carrying Case

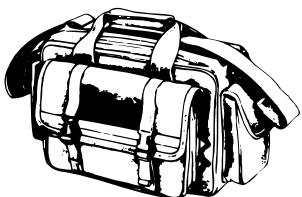

Custom compact soft case designed especially to provide protection and utility for your compact VHS camcorder and most accessories. Rugged fabric lined with soft non-abrasive material and generous padding. Has three outside pockets with storage for lens filters, adapters, batteries, and tapes.

### DCC08 Car Cord Adapter

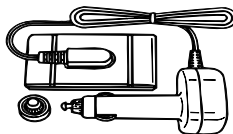

**Do not use any other car cord with this camcorder.**

This car cord adapter enables you to operate your camcorder from your car, truck, or RV by plugging the car cord directly into the vehicle's cigarette lighter socket. The DCC08 is designed specifically to convert power from a 12-volt battery to a 6-volt output.



## Optional Accessories

### FB1260 Rechargeable Battery

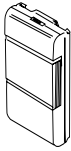

This rechargeable, 1-hour, nickel-cadmium battery is designed specifically for long life. The FB1260 can be recharged with the AC adapter/charger that came with your camcorder.

### BB99L Rechargeable Battery

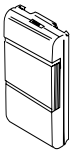

This rechargeable 2-hour, nickel metal hydride battery is designed specifically for long life. The BB99L is a 1-hour nickel cadmium battery. The BB99L powers your camcorder approximately twice as long as the FB1260 (depending on how much you use zoom and pause). The BB99L can be recharged with the AC adapter/charger that came with your camcorder.

All specifications and descriptions of accessories are subject to change without notice.

### CPS91 AC Battery Charger

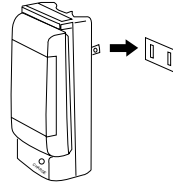

The CPS91 battery charger plugs directly into an AC outlet and charges the FB1260 and BB99L camcorder batteries. Because the CPS91 operates on 100-240 Volts, 50/60 Hz, it can be used virtually anywhere in the world. A plug adapter might be required in some countries. Charging takes approximately seven hours for the FB1260 (1-hour battery), and 13 hours for the BB99L (2-hour battery).

### VH83 Audio/Video Cable

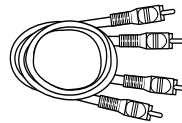

This six foot audio/video cable can be used to connect the camcorder to a TV monitor or VCR for tape playback or copying tapes.

### AH25 Y-Adapter



This Y-adapter allows you to connect your camcorder's mono audio cable to a stereo TV or VCR.

## Optional Accessories

### Using the Optional AC088 Tripod

Mounting the camcorder on a tripod, such as AC088, keeps the camcorder steady and produces excellent video results.

This tripod's fluid-effect head provides smooth camera pan and tilt. The quick-release mount makes it easy to attach or remove the camcorder. The grooved, tubular 3-section leg design folds down to 26" when not in use. Rubber feet allow for sure footing.

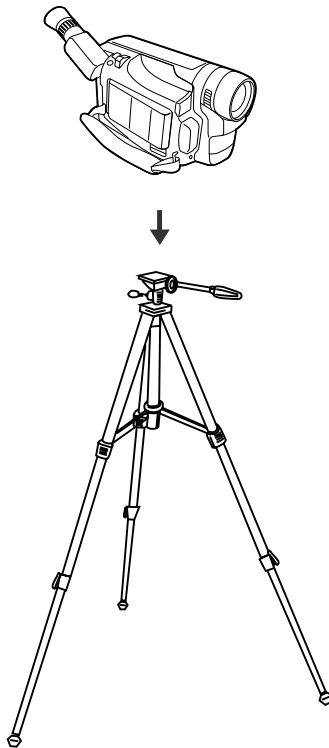

**Cautions:** Before using a tripod, make sure it is stable enough to hold the camcorder without falling over. Do not transport the camcorder attached to the tripod.

When attaching your camcorder to a tripod, be careful not to force the tripod screw into the camcorder's tripod mounting hole.

The tripod screw should not protrude into the camcorder more than approximately three-eighth (3/8) inch. Forcing the screw could damage the mounting hole on the bottom of the camcorder.

# Accessory Order Form

## Order Form for Camcorder Model CC6263

| Description                           | Part No.         | Price                | Qty. | Total |
|---------------------------------------|------------------|----------------------|------|-------|
| Super Lightweight Tripod              | AC088            | \$ 49.95             |      |       |
| Soft Camcorder Case                   | AC201A           | \$ 34.95             |      |       |
| Shoulder Strap                        | ACS091           | \$ 12.95             |      |       |
| Y-Adapter                             | AH25             | \$ 2.95              |      |       |
| Rechargeable Battery (Extended)       | BB99L            | \$ 77.60             |      |       |
| AC Battery Charger                    | CPS91            | \$ 59.95             |      |       |
| Car Cord Adapter                      | DCC08            | \$ 89.95             |      |       |
| Rechargeable Battery (Standard)       | FB1260           | \$ 49.95             |      |       |
| Audio/Video Cable                     | VH83             | \$ 5.95              |      |       |
| DC Cable<br>and<br>AC Adapter/Charger | 244268<br>242740 | \$ 28.60<br>\$ 91.25 |      |       |
| Cassette Adapter                      | VCA115           | \$ 49.95             |      |       |

Prices are subject to change without notice.

Total Merchandise ..... \$ \_\_\_\_\_

Sales Tax ..... \$ \_\_\_\_\_

We are required by law to collect the appropriate sales tax for each individual state, county, and locality to which the merchandise is being sent.

Shipping and Handling ..... \$ **5.00**

**Total Amount Enclosed** ..... \$ \_\_\_\_\_

Use VISA, MasterCard, or Discover.  
Money order or check must be in U.S.  
currency only. No COD or cash.

Detach Here

Please complete other side also

# Accessory Order Form

Charge your order on your VISA, MasterCard,  
or Discover Card by filling in below

## USE YOUR CREDIT CARD

**IMPORTANT:** Copy complete account number from your VISA card

Expiration date:



**IMPORTANT:** Copy complete account number from your MasterCard

Copy Number above your name on MasterCard

Expiration date:



**IMPORTANT:** Copy complete account number from your Discover Card

Expiration date:



\_\_\_\_\_  
**AUTHORIZED SIGNATURE**

Prices are subject to change without notice.

Print or type your name and  
address clearly.

A complete and correct order will  
save you days of waiting.

Name: \_\_\_\_\_

Street: \_\_\_\_\_

\_\_\_\_\_ Apt: \_\_\_\_\_

City: \_\_\_\_\_

State: \_\_\_\_\_ Zip: \_\_\_\_\_

Daytime Phone No.: \_\_\_\_\_

**Please make sure that both sides of this form have been filled out completely.**

- Allow 4 weeks for delivery.
- All accessories are subject to availability.

Detach Here 

# Accessory Order Form

## **To order accessories, contact your local Dealer.**

If a dealer is not nearby, you can also follow the directions below to order by telephone or direct-by-mail.

## **United States and Canada Orders**

To place your order by phone, have your Visa, MasterCard, or Discover card ready and call the toll-free number listed below.

**Use this number only to place an order for accessory items listed on this order form.**

**1-800-338-0376**

To place your order by mail, detach and mail the completed order form with credit card information, money order, or check in U.S. currency (made payable to Thomson Consumer Electronics, Inc.) to the following address:

Video Accessories  
PO Box 8419  
Ronks, PA 17573

## Trouble Checks

Troubles sometimes are caused by simple “faults” that you can easily correct without the help of a service technician by first checking a few basic remedies.

Before you call or take your camcorder to an Authorized RCA Camcorder Service Center, look below for the type of trouble you are experiencing. Then perform the simple checks and adjustments listed for that trouble.

If service should be necessary, the warranty information lists what your warranty covers and explains how to get service.

| Trouble                    | Checks and Adjustments  |
|----------------------------|---|
| No power                   | <ul style="list-style-type: none"> <li>• Set the <i>POWER</i> switch to <i>CAMERA</i> or <i>VCR</i> to turn on the camcorder. The power indicator lights.</li> <li>• If using battery, it might need to be recharged.</li> <li>• If using AC adapter/charger, make sure it is plugged into a working outlet.</li> </ul>   |
| Won't record or playback   | <ul style="list-style-type: none"> <li>• If using AC adapter/charger, make sure it is plugged into a working outlet.</li> <li>• If <i>CONDENSATION OPERATION PAUSED PLEASE WAIT</i> flashes in the viewfinder, there is moisture in the camcorder. Wait until the warning no longer appears before operating the camcorder.</li> <li>• Make sure <i>POWER</i> switch is set to correct position for desired operation.</li> <li>• There might not be a cassette in the camcorder.</li> <li>• Try ejecting and reinserting the cassette.</li> <li>• The cassette tape might be broken, try another cassette.</li> <li>• You might have reached the end of the cassette, try rewinding it.</li> </ul> |
| Won't playback             | <ul style="list-style-type: none"> <li>• <i>POWER</i> switch must be set to <i>VCR</i> position.</li> </ul>   |
| Won't record               | <ul style="list-style-type: none"> <li>• Safety tab removed or closed. (<i>See page 22.</i>)</li> <li>• <i>POWER</i> switch must be set to <i>CAMERA</i>.</li> </ul>  |
| No picture                 | <ul style="list-style-type: none"> <li>• Open lens cover.</li> </ul>  |
| Camcorder turns itself off | <ul style="list-style-type: none"> <li>• Set <i>POWER</i> switch to <i>OFF</i> and then to <i>CAMERA</i> or <i>VCR</i> to turn back on. If camcorder is left in record-pause or play-pause for several minutes, it turns off to prevent tape wear.</li> </ul>   |

## Trouble Checks

| Trouble                                  | Checks and Adjustments   |
|--|--|
| Tape stops during rewind or fast forward | <ul style="list-style-type: none"> <li>• Time-counter memory might be on. Whenever an “M” appears with the time-counter display, the camcorder stops rewinding (or fast forwarding) when counter reads <i>M 0:00:00</i>. Press <i>REW</i> ◀◀ or <i>FF</i> ▶▶ again to continue rewinding or fast forwarding, or press <i>COUNTER R/M</i> to turn off the memory-stop feature.</li> </ul>   |
| Camcorder remains in pause mode          | <ul style="list-style-type: none"> <li>• Press <i>PLAY/PAUSE</i> to return to normal playback.</li> </ul>  |
| Dew indicator flashes in viewfinder      | <ul style="list-style-type: none"> <li>• If <i>CONDENSATION OPERATION PAUSED PLEASE WAIT</i> flashes, there is moisture in the camcorder. Wait until warning no longer appears before operating the camcorder.</li> </ul>  |
| Poor auto-focus operation                | <ul style="list-style-type: none"> <li>• Subject is dark or behind glass. Auto-focus may not work under these conditions. Place <i>POWER</i> switch in <i>CAMERA MAN</i> and focus manually. <i>See pages 36-37.</i></li> <li>• Subject not in center of viewfinder or two subjects are at different distances. Place <i>POWER</i> switch in <i>CAMERA MAN</i> and focus manually. <i>See pages 36-37.</i></li> <li>• Lens is smudged, and image appears unfocused.</li> </ul> |
| Viewfinder displays are out of focus     | <ul style="list-style-type: none"> <li>• Lens is smudged and image appears unfocused.</li> <li>• Eyepiece focus control is misadjusted.</li> </ul>   |
| Picture is too dark or subject too dark  | <ul style="list-style-type: none"> <li>• For best results, only use higher shutter speeds outdoors. Press <i>P. AE</i> button to select <i>SPORTS</i> or <i>1/2000</i>. <i>See page 44.</i></li> <li>• Place <i>POWER</i> switch in <i>CAMERA MAN</i> and adjust the exposure manually. <i>See pages 40-41.</i></li> </ul>   |
| Sound is too low or distorted            | <ul style="list-style-type: none"> <li>• Subject was too far from camcorder.</li> </ul>  |
| Picture recorded with special effect     | <ul style="list-style-type: none"> <li>• Place <i>POWER</i> switch in <i>CAMERA AUTO</i>.</li> </ul>   |
| Colors do not look natural on recording  | <ul style="list-style-type: none"> <li>• Try adjusting white balance. <i>See pages 38-39.</i></li> </ul>   |
| Title recorded on tape                   | <ul style="list-style-type: none"> <li>• Title is recorded when it appears in viewfinder. Remove the title. <i>See pages 46-47.</i></li> </ul>   |

## Trouble Checks

| Trouble   | Checks and Adjustments  |
|---|---|
| Date and/or time are recorded on tape   | <ul style="list-style-type: none"> <li>• Displays are recorded on tape whenever they appear in the viewfinder. Remove them from viewfinder when recording. <i>See pages 20-21.</i></li> <li>• When <i>AUTO DATE</i> is selected (<i>POWER</i> switch in <i>CAMERA AUTO</i>), date display is automatically recorded when you begin recording or change the cassette. <i>See pages 20-21.</i></li> </ul> |
| Date and/or time are incorrect  | <ul style="list-style-type: none"> <li>• Clock lithium cell battery might need replacing. <i>See page 17.</i></li> <li>• Date or time might need to be set. <i>See pages 18-19.</i></li> </ul>  |
| Cannot set <i>REC</i> or <i>INT. TIME</i> for animation or time-lapse recording | <ul style="list-style-type: none"> <li>• Make sure there is a tape in the camcorder.</li> <li>• Check tape speed setting. Tape speed must be set to SP for time-lapse or animation recording.</li> <li>• Make sure <i>POWER</i> switch is not set to <i>CAMERA AUTO</i> to display the menu. <i>See pages 50-53.</i></li> </ul>   |
| Cannot record at beginning of tape using animation or time-lapse recording      | <ul style="list-style-type: none"> <li>• Record for at least five seconds at beginning of tape to start tape running smoothly.</li> <li>• Use fade-in feature before starting to record at beginning of tape.</li> </ul>  |
| Vertical white lines appear when shooting bright object                         | <ul style="list-style-type: none"> <li>• This might occur when the background extremely contrasts with the subject.</li> </ul>  |
| Error number ( <i>E01</i> , <i>E02</i> , etc.) appears in viewfinder            | <ul style="list-style-type: none"> <li>• Try disconnecting power source. Wait ten seconds and then connect power source again. If error number does not disappear from viewfinder, consult your Authorized RCA Camcorder Service Center.</li> </ul>   |
| Streaks in picture during playback or play-pause                                | <ul style="list-style-type: none"> <li>• Adjust tracking with <i>P.AE</i> and <i>FADES</i> buttons. <i>See page 57.</i></li> </ul>  |
| Bright, crystal-shaped spots in viewfinder                                      | <ul style="list-style-type: none"> <li>• Sunlight is directly entering the lens.</li> </ul>   |



## Trouble Checks

| Trouble   | Checks and Adjustments   |
|---|--|
| Rechargeable battery runs down sooner than expected | <ul style="list-style-type: none"><li>• If battery has not been used for some time, completely drain the battery's power and recharge it.</li><li>• Battery run times are measured when the camcorder is recording continuously. You can check your battery by first fully charging it and then aiming the camcorder at a clock and recording the picture of the clock. When the recording stops, play the last recorded section and note the clock time. A one-hour battery should give you about 60 minutes of recording time. In practical use, you might not be able to record for the full time because the camera uses battery power when it is waiting between recordings (record-pause) and zooming.</li></ul> |

# Specifications

## General

Power requirement: 6VDC  
Power consumption: 3.6 watts  
Weight: 1.6 lbs. (720g)

## Dimensions – Including Viewfinder:

3-9/16" (W) x 4-11/16" (H) x 7-13/16" (D)  
90 (W) x 119 (H) x 198 (D) mm

## Video Recorder Section

Format: VHS-C  
Record/playback system:  
Four video record/playback heads  
One flying erase head  
Video signal: EIA standard  
NTSC color

## Viewfinder

0.44" Color electronic viewfinder

## Camera Section

Image sensor: 1/4" CCD imager  
Lens: F1.6, f=3.9 to 62.4mm  
16:1 power zoom lens  
200:1 digital zoom  
Filter diameter: 40.5 mm

## Tripod Mount

One 1/4" x 20 threaded hole

## AC Adapter/Charger

Power requirement: 100-240 V, 50/60 Hz.  
Power consumption: 23 watts  
Weight: .71 lbs. (300g)  
Dimensions:  
5-9/16"(W) x 1-11/16"(H) x 2-11/16"(D)  
140 (W) x 42 (H) x 68 (D) mm

## Service Port

3.5 mm, 4 pole, mini-head jack

# Care and Maintenance

## Clean the Camcorder

To clean the camcorder's exterior, remove any power source connected to the camcorder and gently wipe it with a clean soft cloth.

**Caution:** Use of strong cleaning products, such as those containing alcohol or benzine, might damage the camcorder.

## Clean the Camcorder's Lens

To clean the camcorder's lens, blow it with a blower brush and gently wipe the lens with cleaning tissue and commercially prepared cleaning solution designed for use on camera lens. Improper cleaning might scratch the lens.

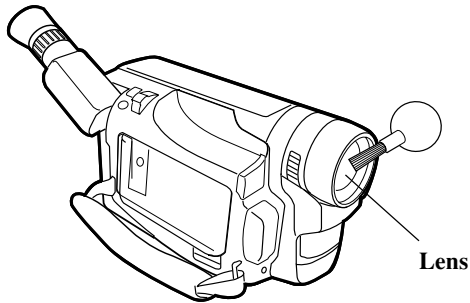

**Caution:** Do not touch the lens with your fingers. The oil from your skin might damage the lens.

## Clean the Camcorder's Viewfinder

You can remove the viewfinder eyepiece for cleaning.

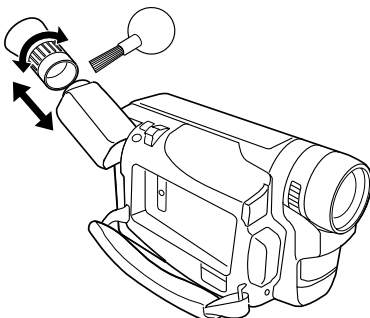

1. Turn the eyepiece counterclockwise and pull it out.
2. Remove dust using a blower brush.
3. Reattach the eyepiece by aligning the reference marks, and then turn the eyepiece clockwise until it clicks.

## Proper Care and Storage

- Keep dust and grit from entering the camcorder's cassette door. Dust and grit are abrasive and cause excessive wear to both the camcorder's recording/playback heads and cassettes.
- Always close the lens cover when the camcorder is not in use.
- Before handling your camcorder, make sure your hands and face are free from any chemical products such as suntan lotion, as it might damage the finish.
- The camcorder might be damaged by improper storage or handling. Do not subject the camcorder to swinging, shaking, or dropping.
- Do not store the camcorder in temperatures below -22°F (-30°C) or above 149°F (65°C).
- When the camcorder is not in use, always remove the cassette and AC adapter/charger or battery.
- Retain the original carton for future storage or shipping purposes.

## Things to Avoid

- Do not attempt to disassemble your camcorder. There are no user-serviceable parts inside.
- Avoid operating your camcorder immediately after moving it from a cold location to a warm location. Give the camcorder 1-1/2 to 2 hours to reach a stable temperature before inserting a cassette. When the camcorder is moved from cold to warm, condensation might cause the tape to stick to the headwheel and damage the headwheel or tape.
- Do not aim your camcorder at the sun or other bright objects.
- Do not leave your camcorder in direct sunlight for extended periods of time. The resulting heat buildup might permanently damage the camcorder's internal parts.
- Do not operate the camcorder in extremely humid environments.
- Do not operate the camcorder near the ocean as salt water or salt water spray might damage the internal parts of the camcorder.
- Do not operate the camcorder for extended periods in temperatures below 40°F (4°C) or above 95°F (35°C).
- Do not expose the camcorder or adapter/charger to rain or moisture. If any component becomes wet, turn off the power and take the unit to an Authorized RCA Camcorder Service Center.
- Do not use an adapter/charger or batteries other than the ones specified for the camcorder. Use of the wrong accessories might cause damage to the camcorder.

# Customer Assistance and Service

You can reach Thomson at the following number:

**800-283-6503**

(Toll free inside U.S.A.)

Our toll-free Camcorder number operates from 8 a.m. to 5 p.m., CST Monday – Friday for U.S. customers only

Thomson provides a toll-free telephone number to help you with any problems you may encounter with your camcorder. Many can be diagnosed over the phone, and if necessary, repair or replacement will be arranged. Please have your camcorder model/serial number and date of purchase ready when you call. If your unit is out of warranty, we will quote the cost of a repair or replacement unit to you.

## Returning equipment to Thomson for repair or exchange

If we are unable to resolve your problem over the phone, we will gladly service your unit or exchange it for a new or refurbished camcorder. Refer to the limited warranty on the reverse side to learn about your specific rights and responsibilities.

*Always consult Thomson and get a Return Authorization number before returning anything!* Obtain a Service Request (SR) number from the telephone representative before returning your equipment to avoid delays, accounting errors, or even loss of your unit.

## Important information to customers who ship defective equipment to Thomson Consumer Electronics

The Thomson representative who authorized the return of your equipment will give you an SR number over the phone. They will also provide you with instructions on where and how to return your Camcorder. Write the number in large, clear characters on the outside of the box. To avoid confusion and misunderstandings, shipments without an SR number clearly visible on the outside of the box will be returned to you at your expense.

Include a brief note describing the problem and any conversations about the problem you have had with Thomson personnel.

Include your name, address and model/serial number of your Camcorder. These numbers

are located on the bottom of your unit.

If your Camcorder is within the warranty period, please provide a copy of the bill of sale to verify purchase date. Use the original box and packing material to protect the equipment from damage in shipment.

*For your protection, insure all shipments for full replacement value and use a reliable shipper.* Thomson assumes no responsibility for warranty shipments from the customer to the factory if not shipped in the manner prescribed by Thomson.

# Limited Warranty

## What your warranty covers:

- Any defect in materials or workmanship.

## For how long after your purchase:

- 90 days for labor charges.
- One year for parts.

The warranty period for rental units begins with the first rental or 45 days from date of shipment to the rental firm, whichever comes first.

## What we will do:

### During the initial 90 days

- Exchange your camcorder with a new or refurbished unit, or repair your camcorder. The option will be ours. There will be no cost to you.

### After the 90 days and within one year

- Exchange your camcorder with a new or refurbished unit, or repair your camcorder. The option will be ours. Parts will be provided at no charge, but you will be responsible for the cost of labor required for the repair.

## How you get service:

- Call 1-800-283-6503 and have your unit's date of purchase and model/serial number ready. The model/serial number information is on the bottom of your camcorder.
- A representative will troubleshoot your problem over the phone. If the representative determines that you should receive a replacement unit, you will be provided with a Service Request (SR) number and the location of a nearby exchange point if one exists. No returns will be accepted without the SR number.

**To receive a replacement Camcorder before you return yours:**

## Option I

1. Provide your Discover, MasterCard, or Visa account number and expiration date to our phone representative. This is for security purposes. If we receive your unit, excluding all accessories, within 14 days from the date you were provided the SR number, only items not covered by warranty will be charged to your account. **IF YOUR UNIT IS NOT RECEIVED WITHIN 14 DAYS, THE SUGGESTED RETAIL VALUE OF THE CAMCORDER WILL BE CHARGED TO YOUR CREDIT CARD.** This amount, less \$10.00 handling, will be credited if the unit is subsequently received.
2. We will send you a replacement unit.
3. Ship the unit back to us, excluding all accessories, using the replacement unit's carton. Shipping instructions will be included in the carton along with your SR number which will allow you to easily ship the unit back to us. **Make sure you insure your shipment in case of damage or loss.** Include with the shipment:
  - Evidence of purchase date, such as a bill of sale to verify your unit's warranty eligibility.
  - A brief note describing your camcorder's problem.
  - Your name, address and phone number.

Return transportation, storage, handling, and insurance costs are your sole responsibility. We accept no liability in case of damage or loss.

## Option II

1. We will send a replacement unit to the exchange point.
2. The exchange location will notify you of its arrival.
3. Take your unit, excluding all accessories, and your evidence of purchase date, such

# Limited Warranty

as a bill of sale, to the exchange location and you will be provided the new or refurbished unit.

4. If the repairs were covered by your warranty, you will not be billed.

To receive a replacement unit after we have received your unit:

1. **Write the SR number on the outside of the carton used to return the unit. Make sure you insure your shipment in case of damage or loss.**
2. Carefully pack the unit, excluding all accessories, using the original box and packing material if possible.
3. Include with the shipment:
  - Evidence of purchase date, such as a bill of sale, to verify your unit's warranty eligibility.
  - A brief note describing your camcorder's problem.
  - Your name, address and phone number.

Return transportation, storage, handling, and insurance costs are your sole responsibility. We accept no liability in case of damage or loss.

4. The representative will advise the address to mail a cashier's check or money order for payment if there are any out of warranty labor or parts charges and you elect not to use your credit card.
5. Upon receipt of your product, a new or refurbished unit will be shipped to you.

## **To have your Camcorder repaired by an Authorized RCA Camcorder Service Center:**

- Check with your dealer or call 1-800-336-1900 for the Authorized RCA Camcorder Service Center nearest you.
- Take your unit to the Authorized RCA Camcorder Service Center of your choice.
- Show the Authorized RCA Camcorder Service Center representative evidence of purchase date, such as a bill of sale.

- Pick up your camcorder when repairs are complete.

## **What your warranty does not cover:**

- Adjustment of customer controls.
- Damage from misuse or neglect.
- A unit that has been modified or incorporated into other products or is used for institutional or other commercial purposes.
- Batteries for remote control and clock.
- Cleaning of video/audio heads.
- Camcorders purchased or serviced outside the U.S.A.
- Return transportation, storage and handling costs of your unit, including insurance for loss or damage.
- Acts of God, such as but not limited to lightning damage.

## **Product Registration:**

- Please complete and mail the Product Registration Card packed with your camcorder. It will make it easier to contact you should it ever be necessary. The return of the card is not required for warranty coverage.

## **How State Law relates to warranty:**

- This warranty gives you specific legal rights and you also may have other rights that vary from state to state.

## **If you purchased your camcorder outside the United States:**

- This warranty does not apply. Contact your dealer for warranty information.

## Symbols

5SEC. REC button 31

## A

A (audio) and V (video)  
jacks 60

Accessories

included 3

optional 62

order form 65

Adapter/charger 4, 12

charging battery 14

Animation indicator 49

Animation recording 48

Assistance 1, 3

Assistance, customer 75

Audio/video jacks 10, 60

AUTO DATE display  
20, 21

Auto date feature 32

Auto exposure 40

Auto focus 36

Auto white balance 38

AutoShot™ 5, 32

## B

Battery

attaching and removing  
13

care and storage 15

cassette adapter 58

charging 14

refreshing 14

Battery level indicator

15, 28, 33

BATTERY RELEASE

lever 10, 13

## C

Camcorder, cleaning 73

Camcorder controls 9

Camera edit feature 33

Car cord adapter 16

Care and maintenance

battery 15

camcorder cleaning 73

cassette 23

storage 74

things to avoid 74

Cassette

adapter 58

inserting and removing  
23

tape wheel 23

warning 28

Cautions i2

Checks and adjustments  
68

Clock cell battery com-  
partment 11, 17

Clock cell indicator  
17, 31

Copy tapes 61

COUNTER R/M button  
9, 57, 61

Customer assistance and  
service 75

## D

Date and time display

recording 20

setting 18

DATE/TIME menu

7, 35, 37, 46, 51

DC cable 12, 13, 14, 16

DC in jack 4, 10, 12

Demo mode 52

Digital zooming 34

Displays in viewfinder 28

Displays, status 29

## E

EJECT button

6, 9, 23, 55

Erase protection 22

Exposure control 41  
indicators 30

Exposure indicators 41

Eyepiece focus control  
5, 11, 27, 55

## F

Fade and wipe indicators  
30, 42

Fade/wipe feature 43

FADES button 57

Fast forward indicator 29

FF button 9, 56

First time operation 3

Five-second recording 33

Five-second recording  
indicator 31

Flying erase head 33

Focus indicators 30, 37

Focusing 36, 37

## H

Handstrap 4

## I

Indicators

animation 49

AUTO DATE display  
28

battery level 15

cassette warning 28

clock cell 17, 31

date and time 28

exposure 30, 41

fade and wipe 30, 42  
five-second recording  
31

focus 30, 37

interval time 51

LENS COVER 31

manual white balance  
29



## Indicators (*Cont.*)

- P. (program) AE 28, 44
  - record time 49, 51
  - REFRESH 14
  - special effects 28
  - steady pix 31, 41
  - TAPE END 31
  - tape length 31
  - tape speed 31
  - tape-remaining 31
  - time counter 31
  - time display 28
  - time-lapse 51
  - title display 28
  - tracking 29
  - white balance 39
  - zoom level 29, 34
- Information to user 81
- Inserting/removing  
cassettes 23
- Interval time indicators  
51

## L

- Lens 10
- Lens cover 8
- LENS COVER control 4
- LENS COVER indicator  
31
- Letterbox recording 45
- Lithium cell 17, 31
- Low-contrast indicator 36

## M

- M.W.B. menu 39, 40
- Manual focus 37
- Manual white balance 38
- indicator 29
- Memory stop 57
- Menu PUSH dial  
7, 9, 18, 19, 21, 24, 25, 32,  
35, 37, 38, 40, 45, 46, 47,  
49, 51, 52

- MENU/DISPLAY button  
7, 9, 18, 28, 32, 33,  
34, 35, 46, 48, 50, 52
- Microphone 10, 32

## O

- Operating controls 10
- Optional accessories 62
- Optional plug adapter 12
- Order form, accessories  
65

## P

- P. (program) AE button  
9, 28, 44, 57
- Pause indicator 6, 8, 29
- Pause, stop-action 56
- Play indicator 29
- PLAY/PAUSE button  
8, 55, 61
- Playback  
first 8
- on TV (or VCR) 60
- using cassette adapter  
58
- viewfinder 55
- Playback features  
memory-stop 57
- position the tape 56
- speeds 22
- stop-action pause 56
- time counter 57
- tracking 57
- visual searching 56
- Plug adapter 12
- Power indicator  
5, 8, 10, 16, 32
- POWER switch  
5, 15, 24, 28, 34, 35, 40,  
42, 57, 61
- Powering your camcorder  
adapter/charger 12
- car cord adapter 16
- rechargeable battery 13

- Preset titles 46
- Problem solving 68
- Product registration i2
- PUSH button 55

## Q

- Quick review feature 33

## R

- REC TIME menu 49
- Record date and time  
display 20
- Record indicator 8
- Record time indicators 49
- Recording 8
- indicator 29
- speeds 6, 22
- time-lapse 50
- tips 26
- REFRESH 14
- Registration i2
- REW button 8, 56, 57
- Rewind indicator 29

## S

- Safety  
battery 13
- Safety information i2
- Safety tab 22
- SEARCH buttons 33
- Search indicators 29
- Service port 10
- Shoulder strap  
Attaching 53
- attachment rings 9
- Shoulder strap attachment  
rings 53
- Shutter speed indicator 44
- Solving problems 68
- SP/SLP button  
9, 22, 24, 31, 33, 48, 50
- Special effects 28

- Specifications 72
  - Speeds, recording and playback 22
  - Sports feature 44
  - Status displays 29
  - STEADY PIX button
    - 10, 31, 41
  - Steady pix indicator 31
  - STOP button
    - 8, 55, 57, 61
  - Stop-action pause 56
- T**
- Tape copying 61
  - TAPE END indicator 31
  - Tape, inserting 6
  - Tape length indicators 31
  - TAPE LENGTH menu
    - 24, 31
  - Tape speed
    - SLP 6, 22
    - SP 6, 22
  - Tape speed indicators 31
  - Tape wheel 6
  - TELE MACRO menu 35
  - Tele macro zooming 35
  - Thumb trigger
    - 10, 21, 32, 49, 51, 61
  - Time counter 57
  - Time-lapse indicator 51
  - Time-lapse recording 50
  - Time-remaining display
    - 24, 31
  - Tips
    - recording 26
    - travel 54
  - TITLE LANG. menu 46
  - TITLE menu 29, 47
  - Tracking 55
    - indicators 29
  - Tracking buttons 57
  - Tracking indicators 57
  - Travel tips 54
  - Tripod mount hole 11
  - Tripod, using 64
  - Trouble checks 68
  - TWILIGHT indicator 29
- V**
- Videocassettes 22
  - Viewfinder 5, 11, 27
    - adjust for viewing 27
    - cautions 27
    - displays 28
    - displays (turning on and off) 33
    - eyepiece focus control
      - 27
    - playback 55
  - Visual searching 56
- W**
- White balance 38
  - Wipe/fade feature 42
- Z**
- Zoom buttons 37
  - Zoom level indicator
    - 29, 34
  - Zoom lever 10, 29, 34
  - Zooming 34
    - tele macro 35

## Information to User

This equipment has been tested and found to comply with the limits for a Class B digital device pursuant to Part 15 of the FCC Rules. These limits are designed to provide reasonable protection against harmful interference in a residential installation. This equipment generates, uses, and can radiate radio frequency energy and, if not installed and used in accordance with the instructions, may cause harmful interference to radio communications. However, there is no guarantee that interference will not occur in a particular installation. If this equipment does cause harmful interference to radio or television reception, which can be determined by turning the equipment off and on, the user is encouraged to try to correct the interference by one or more of the following measures:

- Reorient or relocate the receiving antenna.
- Increase the separation between the equipment and receiver.
- Connect the equipment into an outlet on a circuit different from that to which the receiver is connected.
- Consult the dealer or an experienced radio/TV technician for help.

Alterations or modifications carried out without appropriate authorization may invalidate the user's FCC right to operate the equipment.

This Class B digital apparatus complies with the Canadian ICES-003.

Cet appareil numérique de la Classe B est conforme a la norme NMB-003 du Canada.

 **THOMSON CONSUMER ELECTRONICS**  
**10330 N Meridian Street**  
**Indianapolis, IN 46290**

©2000 Thomson Consumer Electronics, Inc.

Trademark(s)<sup>®</sup> Registered

Marca(s) Registrada(s)

Printed in Japan

**TOCOM 15530270**

**Part No. LYT0520-001A (VP)**